

Current Electricity

LEVEL 1 :>

1] (a)

Same material, i.e. density is same for both wires
As their masses are equal,

$$\rho l_1 A_1 = \rho l_2 A_2$$

$$\frac{l_1}{l_2} = \frac{1}{2} \Rightarrow \frac{l_1}{l_2} = \frac{A_2}{A_1} \Rightarrow \frac{A_2}{A_1} = \frac{1}{2}$$

$$R_1 = \frac{\rho l_1}{A_1} ; R_2 = \frac{\rho l_2}{A_2}$$

$$\therefore \frac{R_1}{R_2} = \frac{l_1}{A_1} \times \frac{A_2}{l_2} \Rightarrow \frac{R_1}{R_2} = \frac{l_1}{l_2} \times \frac{A_2}{A_1} = \frac{1}{2} \times \frac{1}{2}$$

$$\therefore \frac{R_1}{R_2} = \frac{1}{4}$$

$$\text{Now, } P_1 = i^2 R_1 ; P_2 = i^2 R_2$$

$$\therefore \frac{P_1}{P_2} = \frac{R_1}{R_2} = \frac{1}{4}$$

$$\therefore P_2 = 4 \times P_1$$

$$\therefore P_2 = 4 \times 10$$

$$\therefore \boxed{P_2 = 40 \text{ W}}$$

2] (b)

Rate of consumption of energy will be equal to the power of the lamp.

$$P = \frac{V^2}{R}$$

So, if V decreases, Power also decreases.

3] (a)

$$100 = \frac{V^2}{R_1} ; 60 = \frac{V^2}{R_2}$$

$$\therefore \frac{V^2}{R_1} + \frac{V^2}{R_2} = 160 \quad \text{--- (1)}$$

When connected in parallel, ~~total~~ $\frac{1}{R_1} + \frac{1}{R_2} = \frac{1}{R_{eq}}$

$$\therefore P_{eq} = \frac{V^2}{R_{eq}} = V^2 \left(\frac{1}{R_1} + \frac{1}{R_2} \right)$$

$$\text{From (1)} \quad V^2 \left(\frac{1}{R_1} + \frac{1}{R_2} \right) = 160$$

$$\therefore \boxed{P_{eq} = 160 \text{ W}}$$

4] (d)

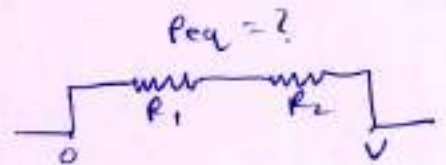
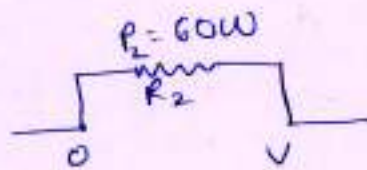
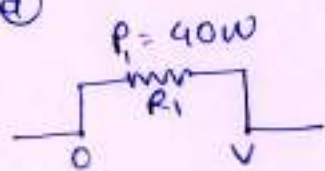

$$P_{eq} = \frac{V^2}{R_1 + R_2}$$

$$P_1 = \frac{V^2}{R_1} ; P_2 = \frac{V^2}{R_2}$$

$$\frac{1}{P_1} + \frac{1}{P_2} = \frac{R_1}{V^2} + \frac{R_2}{V^2} = \frac{R_1 + R_2}{V^2} = \frac{1}{P_{eq}}$$

$$\therefore \frac{1}{P_{eq}} = \frac{1}{P_1} + \frac{1}{P_2}$$

$$\therefore \frac{1}{P_{eq}} = \frac{1}{60} + \frac{1}{40}$$

$$\therefore \boxed{P_{eq} = 24 \text{ W}}$$

5] (a)

When connected in parallel $P_{eq} = P_1 + P_2 = 2000 \text{ W}$

When connected in series $\frac{1}{P_{eq}} = \frac{1}{P_1} + \frac{1}{P_2} \Rightarrow \boxed{P_{eq} = 500 \text{ W}}$

$$\therefore P_p = \frac{Q_p}{t} = 2000 \text{ W} ; P_s = \frac{Q_s}{t} = 500 \text{ W}$$

$$\therefore \frac{Q_p}{Q_s} = \frac{2000 t}{500 t} = 4$$

6] (b)

$$40 = \frac{V^2}{R_1} \quad ; \quad 100 = \frac{V^2}{R_2}$$

$$\therefore \frac{R_1}{R_2} = \frac{100}{40} \Rightarrow R_1 > R_2$$

Now when two lamps connected in series

$$P_1 = i^2 R_1 = \left(\frac{V}{R_1 + R_2} \right)^2 \times R_1 \quad \text{--- (40 W lamp)}$$

$$P_2 = i^2 R_2 = \left(\frac{V}{R_1 + R_2} \right)^2 \times R_2 \quad \text{--- (100 W lamp)}$$

$$\therefore \frac{P_1}{P_2} = \frac{R_1}{R_2}$$

$$\therefore \boxed{P_1 > P_2} \quad (\because R_1 > R_2)$$

\therefore 40 watt lamp will glow brighter

7] (d)

$$P_1 = \frac{V_1^2}{R} \quad ; \quad P_2 = \frac{V_2^2}{R}$$

$$\therefore \frac{P_1}{P_2} = \frac{V_1^2}{V_2^2} = \left(\frac{220}{110} \right)^2 = 4$$

$$\therefore P_2 = \frac{P_1}{4} = \frac{100}{4}$$

$$\therefore \boxed{P_2 = 25 \text{ W}}$$

8] (d)

$$P = \frac{V^2}{R}$$

\therefore P is inversely proportional to R

\therefore For P to be maximum, Resistance should be minimum

$$9] \text{ Power} = \frac{\text{Work (Heat)}}{\text{time}}$$

$$\therefore \frac{V^2}{R} \times t = Q \Rightarrow \frac{(220)^2}{12} \times t = 40 \times 10^3 \times 4.18 \times 65$$

10) (c)

$$\text{Total units for month} = (8 \times 100 + 4 \times 300) \times 30$$

$$= 2000 \times 30$$

$$\therefore \text{Cost} = 60,000 \times \frac{1}{2} \text{ paise}$$

11) (c)

$$i^2 R = mc \Delta T$$

$$\therefore i^2 R = mc (s)$$

Current is doubled $\Rightarrow (2i)^2 R = mc \Delta T'$

$$\therefore 4i^2 R = mc \Delta T'$$

$$\therefore 4 \times mc \times 5 = mc \Delta T'$$

$$\therefore \boxed{\Delta T' = 20^\circ \text{C}}$$

12) (b)

Resistance of one part = $\frac{R}{2n}$

\therefore For series combination

$$R_s = n \times \frac{R}{2n}$$

$$\therefore R_s = \frac{R}{2}$$

$$\therefore P_s = \frac{V^2}{R/2} \Rightarrow \boxed{P_s = \frac{2V^2}{R}}$$

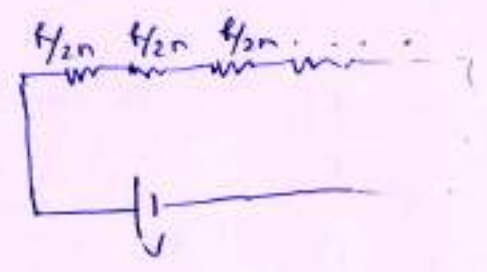

For parallel combination,

$$\frac{1}{R_p} = \frac{1}{R/2n} + \frac{1}{R/2n} + \frac{1}{R/2n} + \dots$$

$$\therefore R_p = \frac{R}{2n^2}$$

$$\therefore P_p = \frac{V^2}{R/2n^2} \Rightarrow \boxed{P_p = \frac{2n^2 V^2}{R}}$$

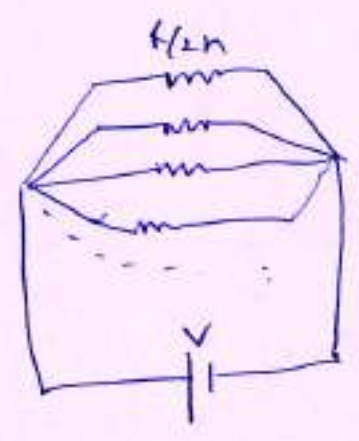

$$\therefore \frac{Q_s}{Q_p} = \frac{P_s t}{P_p t} = \frac{P_s}{P_p} = \frac{2V^2/R}{2n^2 V^2/R} = \frac{1}{n^2}$$

16] (a)

$$W = Z A t$$

(Z = electrochemical equivalent) ⁵

$$P = \frac{V^2}{R} = i^2 R$$

$$\therefore R = \frac{V^2}{P} \Rightarrow P = \frac{i^2 V^2}{P} \Rightarrow i^2 = \frac{P^2}{V^2}$$

$$\therefore i = \frac{P}{V} = \frac{100 \times 10^3}{33}$$

$$\therefore i = \frac{10^5}{33}$$

$$\therefore W = 0.33 \times 10^{-6} \times \frac{10^5}{33} \times (60 \times 60) \quad (t \text{ should be in sec.})$$

$$\therefore W = 3600 \times 10^{-3}$$

$$\therefore \boxed{W = 3.6 \text{ kg}}$$

17] (c)

$$E l = \Delta V = i R$$

$$\therefore E = \frac{i R}{l}$$

$$R = \frac{\rho l}{A} \Rightarrow E = \frac{i \times \rho l}{A \times l} \Rightarrow E = \frac{\rho i}{A}$$

$$\therefore E = \frac{1.7 \times 10^{-8} \times 1}{2 \times 10^{-6}}$$

$$\therefore E = 0.85 \times 10^{-2}$$

$$\therefore \boxed{E = 8.5 \times 10^{-3} \text{ V/m}}$$

13] (b)

P_{max} when $r = R$

$$\therefore R = 4$$

$$\therefore 24 - (4+4)i = 0$$

$$\therefore i = 3 \text{ A}$$

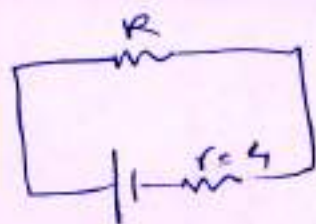

6

14] (c)

$$P_1 = i^2 R$$

$$P_2 = (i - 0.02i)^2 R \Rightarrow P_2 = (i^2 - 2i \cdot 0.02i + (0.02i)^2) R \quad (\because 0.02^2 \approx 0)$$

$$\therefore P_2 = (i^2 - 2i \cdot 0.02i) R$$

$$\frac{P_1}{P_2} = \frac{i^2 R}{i(i - 2 \times 0.02i) R} = \frac{i}{i - 2 \times 0.02i} = \frac{i}{i - 0.04i}$$

$$\therefore \frac{P_1}{P_2} = \frac{i}{0.96i}$$

$$\therefore \frac{P_1}{P_2} = \frac{1}{0.96} \Rightarrow P_2 = 0.96 P_1$$

\therefore Power decreases by 4%.

15] (b)

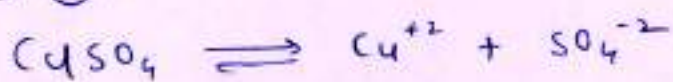

\therefore Charge transferred = 2 x number of copper ions deposited x e

$$\therefore \text{Current} \times \text{time} = 2n \times 1.6 \times 10^{-19}$$

(charge transferred)

$$\therefore 1 \times 10 = 2 \times 1.6 \times 10^{-19} \times n$$

$$\therefore n = \frac{10}{3.2 \times 10^{-19}}$$

$$\therefore n = 3.1 \times 10^{19}$$

6] (a)

$$\begin{aligned} \text{Area of earth surface} &= 4\pi r^2 \\ &= 4\pi \times (64 \times 10^5)^2 \end{aligned}$$

\therefore Charge coming to earth per second

$$\therefore i = 0.15 \times 1.6 \times 10^{-19} \times 10^{24} \times 4\pi \times (64 \times 10^5)^2$$

↓
[converting area into m^2]

$$\therefore i = 12347 \times 10^{-5}$$

$$\therefore \boxed{i = 0.12 \text{ A}}$$

7] (c)

$$i = \frac{dq}{dt} = \frac{d(st^2 + 3t + 1)}{dt} = 10t + 3$$

$$\therefore \text{At } t = 5$$

$$i = 50 + 3$$

$$\therefore \boxed{i = 53 \text{ A}}$$

8] (b)

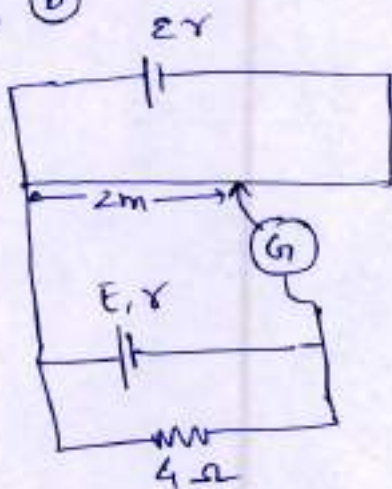

$$\therefore 2z = 4i$$

$$i = \frac{E}{4+r}$$

$$\therefore \boxed{2z = \frac{4E}{4+r}} \quad \text{--- (1)}$$

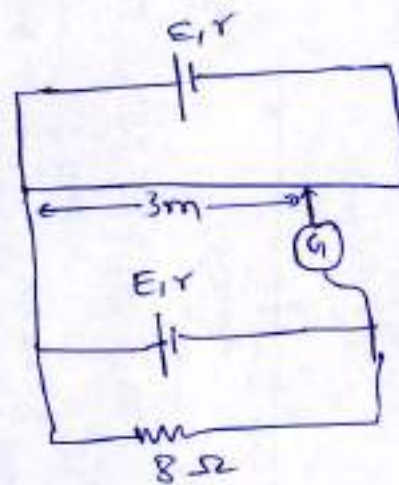

$$3z = 8i$$

$$\therefore \boxed{3z = 8 \left(\frac{E}{8+r} \right)} \quad \text{--- (2)}$$

1] (a)

Rate of flow of electrons \times Area = i = constant

$$\therefore R \times A = \text{constant}$$

$$\therefore R \propto \frac{1}{A}$$

2] (b)

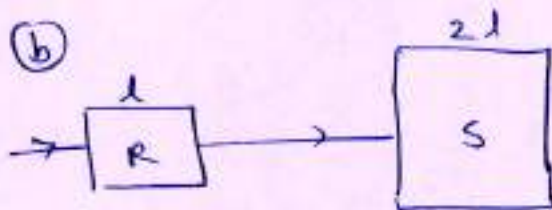
Let the thickness be t .

$$R_R = \frac{\rho l}{A_R} = \frac{\rho l}{l \times t} = \frac{\rho}{t}$$

$$R_S = \frac{\rho \times 2l}{A_S} = \frac{\rho \times 2l}{t \times 2l} = \frac{\rho}{t}$$

$$\therefore R_R = R_S$$

3] (c)

$$R(t) = R_0 (1 + \alpha (t - T_0))$$

$$\therefore 20 = 10 (1 + \alpha (273))$$

$$\therefore 2 = 1 + \alpha (273)$$

$$\therefore \alpha = \left(\frac{1}{273} \right) ^\circ \text{C}^{-1}$$

5] (c)

$$i = neA v_d$$

$$V = iR = neA v_d \times \frac{\rho l}{A} = ne \rho l v_d$$

$$\therefore v_d = \frac{V}{ne \rho l}$$

 $\therefore v_d$ will not depend on A if same V is applied.

Dividing (2) by (1), we get

$$\frac{3}{2} = \frac{8E}{8+r} \times \frac{4+r}{4E}$$

$$\therefore 3(8+r) = 4(4+r)$$

$$\therefore 24+3r = 16+4r$$

$$\therefore \boxed{r = 8 \Omega}$$

11) (c)

It should have high specific resistance and a low melting point so that it would protect electrical appliances by undergoing melting due to excess heat produced because of high resistance ($\because P = i^2 R$)
As a result, the circuit becomes incomplete and no current flows.

12) (b)

$$V = 220$$

$$P = \frac{V^2}{R} \Rightarrow R = \frac{V^2}{P}$$

$$P = i^2 R \Rightarrow P = i^2 \times \frac{V^2}{P} \Rightarrow i^2 = \frac{P^2}{V^2}$$

$$\therefore i = \frac{P}{V}$$

\therefore Maximum current through B_1 will be

$$(i_{\max})_{B_1} = \frac{25}{V} \quad ; \quad (i_{\max})_{B_2} = \frac{100}{V}$$

Now, for series combination $R_{eq} = R_1 + R_2 = \frac{V^2}{P_1} + \frac{V^2}{P_2}$

$$\therefore R_{eq} = \frac{V^2}{25} + \frac{V^2}{100} = \frac{V^2}{20}$$

$$\therefore \text{Current through circuit} = \frac{2V}{R_{eq}} = \frac{2V \times 20}{V^2} = \frac{40}{V}$$

Since $\frac{40}{V}$ is greater than $(i_{\max})_{B_1}$, $[\frac{25}{V}]$, the 25 watt bulb will fuse.

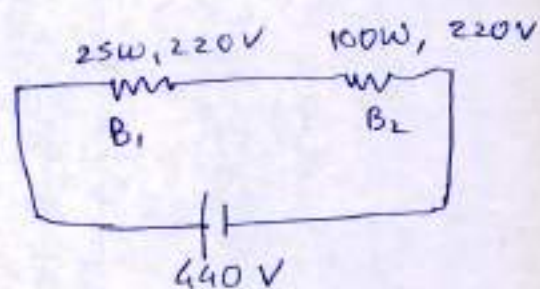

14) (b)

$$i = neAv_d$$

n = no. of free electrons per unit volume.

\therefore Here $n = \frac{\text{no. of atoms}}{\text{volume}}$ (\because no. of atoms = no. of electrons is given)

$$\therefore n = \frac{\text{density} \times \text{volume} \times N_A}{60 \times \text{volume}}$$

$$\therefore n = \frac{5 \times 10^3}{60} \times 6.023 \times 10^{23} \times 10^3 \rightarrow (\text{converting Kg to gram})$$

$$\therefore v_d = \frac{i}{neA}$$

$$\therefore v_d = \frac{16 \times 60}{5 \times 6.023 \times 10^{29} \times 1.6 \times 10^{-19} \times 10^{-5}}$$

$$\therefore \boxed{v_d = 2 \times 10^{-3} \text{ m/s}}$$

18) (b)

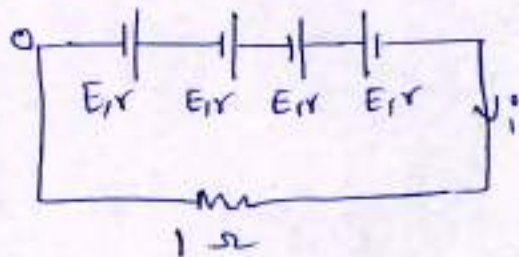

$$3E - E - i(4r + R) = 0$$

$$\therefore 2E - i(4 \times 0.25 + 1) = 0$$

$$\therefore 3 - 2i = 0$$

$$\therefore \boxed{i = 1.5 \text{ A}}$$

19) (b)

$$\frac{E_1}{E_2} = \frac{l_1}{l_2} \Rightarrow \frac{1.08}{E_2} = \frac{400}{440}$$

$$\therefore E_2 = \frac{1.08 \times 440}{400}$$

$$\therefore \boxed{E_2 = 1.188}$$

20] (a)

$$E = Z \times 560$$

$$10i = 2 \times 412$$

$$i(10+Y) = E$$

$$\therefore i = \frac{E}{10+Y}$$

$$\therefore \frac{10E}{10+Y} = 412 \text{ Z}$$

$$\therefore \frac{10 \times 560 \text{ Z}}{10+Y} = 412 \text{ Z}$$

$$\therefore 5600 = 4120 + 412Y$$

$$\therefore Y = \frac{5600 - 4120}{412}$$

$$\therefore Y = 3.6 \Omega$$

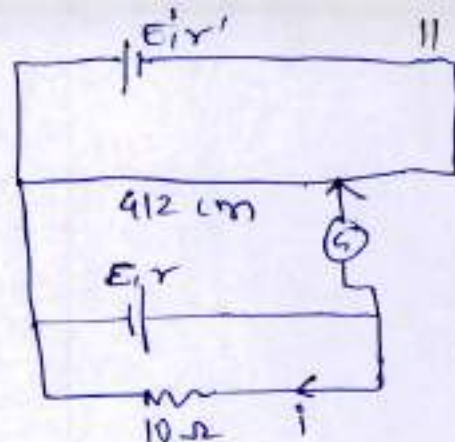

21] (d)

$$R_{eq} = 400 + 800 = 1200 \Omega$$

As the resistance of voltmeter is large, the current through it will be negligible.

$$\therefore 6 - i \times 1200 = 0 \Rightarrow i = 0.005 \text{ A}$$

$$\therefore V_{R_1} = 400 \times 5 \times 10^{-3}$$

$$\therefore V_{R_1} = 2 \text{ V}$$

When voltmeter is connected

$$R_{eq} = \frac{10,000 \times 400}{10,400} + 800 = 1184.61$$

$$\therefore i = \frac{6}{1184.61} = 5.06 \times 10^{-3}$$

$$\therefore V_{R_1} + 11400 i_{R_1} = \frac{10000}{400} (5.06 \times 10^{-3} - i_{R_1})$$

$$\therefore 400 i_{R_1} = 50.6 - 10^4 i_{R_1} \Rightarrow i_{R_1} = 4.86 \times 10^{-3}$$

$$\therefore V'_{R_1} = 400 \times 4.86 \times 10^{-3} = 1.95 \text{ V} \quad \therefore \text{Error} = 2 - 1.95 = 0.05$$

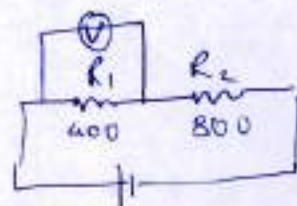

22] (b)

$$\frac{R_1}{R_2} = \frac{3l_1/A_1}{3l_2/A_2} = \frac{l_1}{\pi r_1^2} \times \frac{\pi r_2^2}{l_2} = \frac{l_1}{l_2} \times \frac{r_2^2}{r_1^2} = \frac{4}{3} \times \left(\frac{2}{2.8}\right)^2$$

$$\therefore \frac{R_1}{R_2} = \frac{4}{3} \times \frac{4}{8} \times \frac{9}{4} = \frac{16}{28} = \frac{3}{1}$$

$\therefore i_1 R_1 = i_2 R_2$ (\because they are connected in parallel)

$$\therefore \boxed{\frac{i_1}{i_2} = \frac{R_2}{R_1} = \frac{1}{3}}$$

23] (a)

24] (d)

$$\frac{5}{R} = \frac{2}{3}$$

$$\therefore \boxed{R = \frac{3 \times 5}{2} = 7.5 \Omega}$$

25] (c)

$$i = \frac{2+2}{1.9+0.9+1} = \frac{4}{3.8}$$

$$\therefore V_A = 2 - i \times 1.9$$

$$\therefore V_A = 2 - \frac{4}{3.8} \times 1.9$$

$$\therefore \boxed{V_A = 0}$$

26] (d)

$$2 - (50)i = 0 \Rightarrow \boxed{i = 0.04 \text{ A}}$$

$$E = \frac{40}{100} \times 10 \times 0.04$$

$$\therefore E = 4 \times 0.04$$

$$\therefore \boxed{E = 0.16}$$

27] (c)

$$i = \frac{E}{r+r} = \frac{E}{2r}$$

$$V = ir = \frac{E}{2r} \times r$$

$$\therefore \boxed{V = \frac{E}{2}}$$

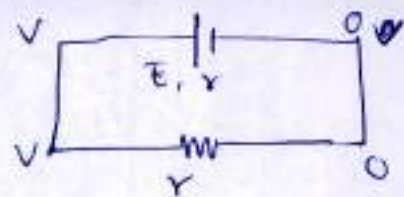

13

28] (a)

Net internal resistance should be equal to R i.e. 3Ω

$$\therefore m=12, n=2$$

30] (a)

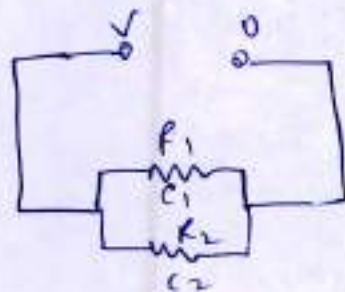
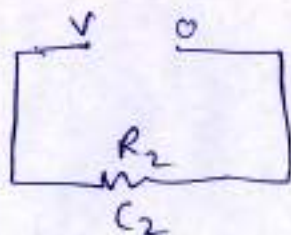

$$P_1 t_1 = P_2 t_2$$

$$\therefore \frac{V^2}{R_1} \times 10 = \frac{V^2}{R_2} \times 15$$

$$\therefore \frac{R_2}{R_1} = \frac{15}{10} = \frac{3}{2}$$

When connected in parallel, $P_{eq} = \frac{V^2}{R_1} + \frac{V^2}{R_2}$

Let the time required be t

$$\therefore P_{eq} \times t = P_1 t_1 = P_2 t_2$$

$$\therefore V^2 \left(\frac{1}{R_1} + \frac{1}{R_2} \right) t = \frac{V^2}{R_1} \times 10$$

$$\therefore \left(\frac{1}{R_1} + \frac{2}{3R_1} \right) t = \frac{10}{R_1}$$

$$\therefore \frac{5}{3R_1} t = \frac{10}{R_1}$$

$$\therefore \boxed{t = \frac{30}{5} = 6 \text{ min}}$$

31] (c)

$$P = \frac{V^2}{R} \Rightarrow 24 = \frac{(12)^2}{R} = i^2 R$$

$$\therefore i^2 = \frac{P}{R} = \frac{P}{V^2/P} = \frac{P^2}{V^2} \Rightarrow i = \frac{P}{V}$$

$$\therefore i = \frac{24}{12} = 2 \text{ A}$$

$$R = \frac{12 \times 12}{24} = 6$$

$$\therefore n \times 1.5 - 2(0.25n + 6) = 0$$

$$\therefore 3n = 4\left(\frac{1}{4}n + 6\right)$$

$$\therefore 3n = n + 24$$

$$\therefore 2n = 24$$

$$\boxed{n = 12}$$

32] (c)

$$100 - 6 \times 2 - 8\left(6 \times \frac{1}{2} + R\right) = 0$$

$$\therefore 88 = 8(3 + R)$$

$$\therefore \boxed{R = 8 \Omega}$$

33] (c)

$$\begin{aligned} \text{Power required for charging the battery} &= VI \\ &= 2 \times 8 \\ &= 16 \text{ W} \end{aligned}$$

$$\therefore P = 6 \times 16 + i^2 R_{eq}$$

$$\therefore P = 96 + 64 \times 11$$

$$\therefore \boxed{P = 800 \text{ W}}$$

34] (a)

$$\text{Heat} = i^2 R = 8^2 \times (8+3)$$

$$\therefore \boxed{\text{Heat} = 704 \text{ W}}$$

35] (c)

$$E = \text{Power} \times \text{time}$$

$$\therefore E = 6V_i \times t$$

$$\therefore E = 6 \times (2 \times 8) \times (2 \times 60)$$

$$\therefore \boxed{E = 11520 \text{ J}}$$

36] (c)

$$P = \frac{V^2}{R} \Rightarrow 100 = \frac{(200)^2}{R}$$

$$\therefore P' = \frac{(100)^2}{R} \Rightarrow P' = \frac{1}{4} \times \frac{(200)^2}{R} \Rightarrow P' = \frac{P}{4} = \frac{100}{4}$$

$$\therefore P' = 25 \text{ W}$$

$$\therefore E = Pt = 25 \times 20 \times 60$$

$$\therefore \boxed{E = 30 \text{ kW}}$$

37] (c)

$$x = nR \quad ; \quad y = \frac{R}{n}$$

$$\therefore xy = R^2$$

$$\therefore \boxed{R = \sqrt{xy}}$$

38] (b)

The value of resistance will not create any difference as there is no current

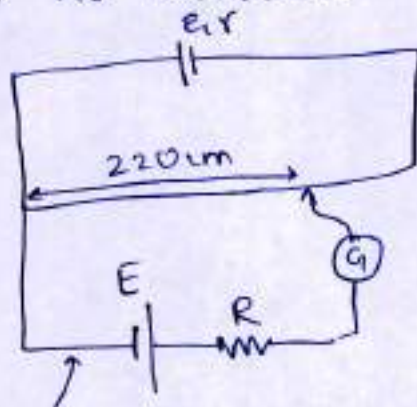

No current here, so the null point does not depend on R

39] (b)

16

For length of 1m,

$$m_a = m_c$$

$$\therefore \rho_a v_a = \rho_c v_c$$

$$\therefore 2700 \times \pi r_a^2 = 8900 \times \pi r_c^2$$

$$\therefore \frac{r_a^2}{r_c^2} = \frac{89}{27}$$

$$\therefore \text{For unit length, } \frac{R_a}{R_c} = \frac{\rho_a / A_a}{\rho_c / A_c}$$

$$\therefore \frac{R_a}{R_c} = \frac{\rho_a}{\pi r_a^2} \times \frac{\pi r_c^2}{\rho_c}$$

$$\therefore \frac{R_a}{R_c} = \frac{\rho_a}{\rho_c} \times \frac{r_c^2}{r_a^2}$$

$$\therefore \frac{R_a}{R_c} = \frac{2.8 \times 10^{-8}}{1.7 \times 10^{-8}} \times \frac{27}{89}$$

$$\therefore \frac{R_a}{R_c} = \frac{2.8 \times 27}{1.7 \times 89}$$

$$\therefore \boxed{\frac{R_a}{R_c} = \frac{1}{2}}$$

1] (d)

$$R = \frac{\int s}{A} \quad \& \quad \underline{\int (b/a)}$$

Take a element at distance r and thickness dr .

$$\therefore dR = \frac{s dr}{4\pi r^2}$$

$$\therefore R = \int_a^b \frac{s dr}{4\pi r^2}$$

$$\therefore R = -\frac{s}{4\pi} \left[\frac{1}{b} - \frac{1}{a} \right]$$

$$\therefore \underline{R = \frac{s}{4\pi} \left[\frac{1}{a} - \frac{1}{b} \right]}$$

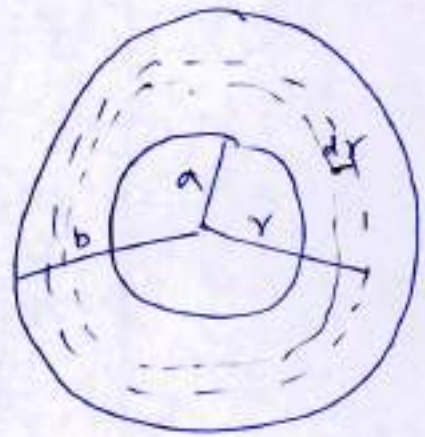

2] (c)

α particle has two protons and 2 neutrons
So, net charge on α particle = $+2e$

As α particle and protons are moving to left and electrons to right, current due to them will be added

$$\therefore i_{net} = \frac{q}{t}$$

$$= \frac{(2 \times 10^{19} + 10^{19} + 10^{19}) \times 1.6 \times 10^{-19}}{1}$$

$$= 4 \times 1.6$$

$$\underline{i_{net} = 6.4 A}$$

3) (c)

$$I = neAv_d$$

$$s = \frac{e}{m_e}$$

$$P = (n \times A \times L) \times m_e \times v_d$$

For unit length $L=1$

$$\therefore P = nA m_e v_d$$

$$\therefore P = nA v_d \times \frac{e}{s}$$

$$\therefore P = \frac{neAv_d}{s} \quad (\because neAv_d = I)$$

$$\therefore \boxed{P = \frac{I}{s}}$$

4) (b)

$$I = 10 + 4t$$

$$\therefore \frac{dq}{dt} = 10 + 4t \Rightarrow q = 10t + 2t^2 \Big|_0^{10}$$

$$\therefore q = 10 \times 10 + 2 \times (100 - 0)$$

$$\therefore \boxed{q = 300 \text{ C}}$$

5) (c)

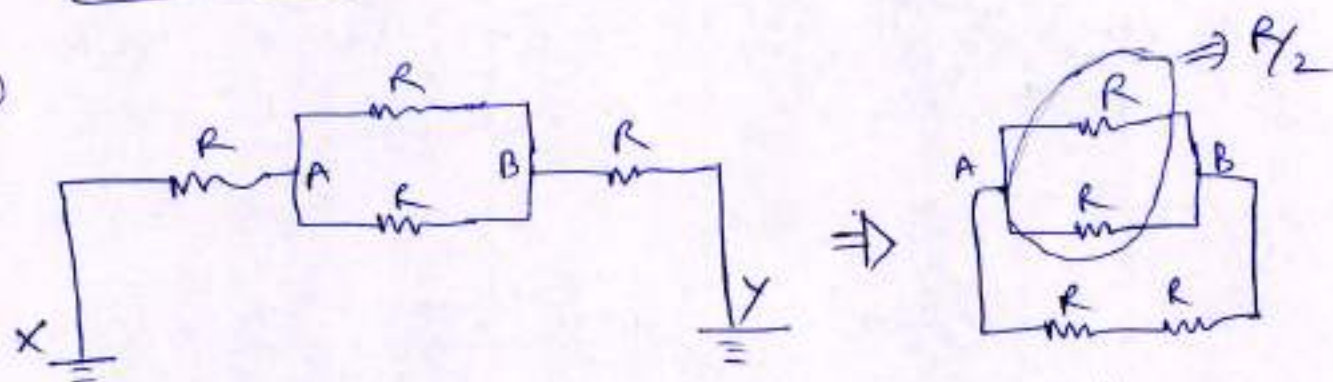

Points X and Y are at same potential.
So they can be joined in circuit

\therefore Now, $\frac{R}{2}$ and $2R$ will be parallel.

$$\therefore R_{eq} = \frac{\frac{R^2}{2}}{\frac{R}{2} + 2R} \Rightarrow \boxed{R_{eq} = \frac{2R}{5}}$$

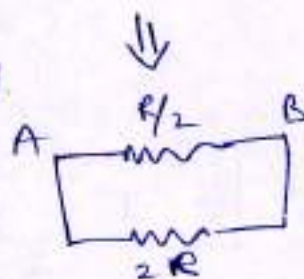

6) (d)

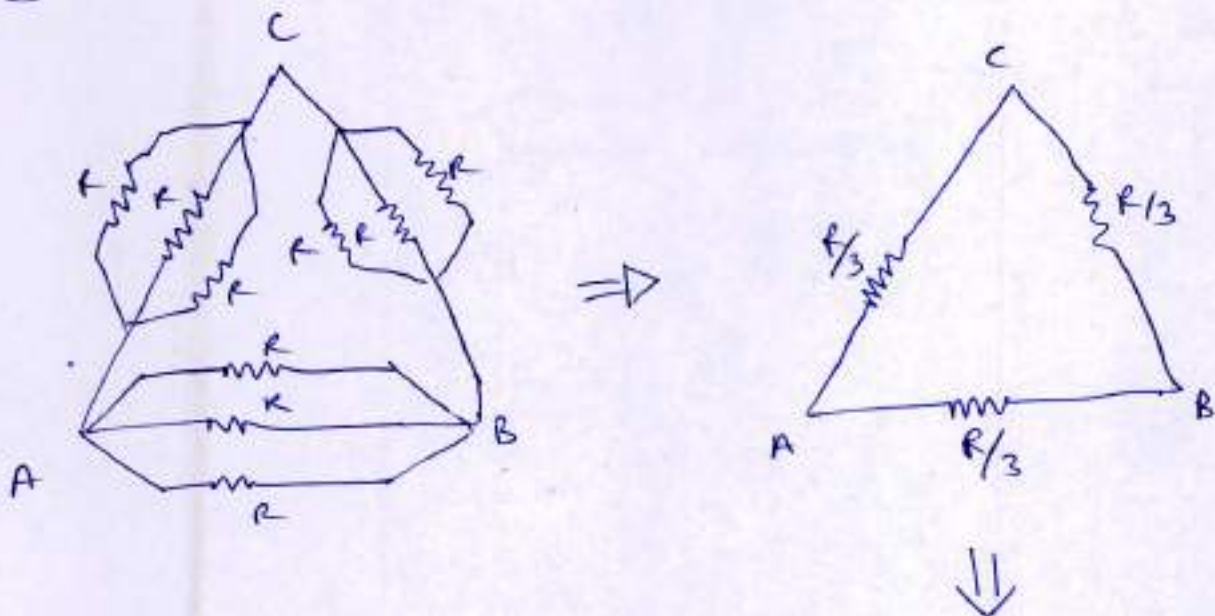

$$\therefore R_{eq} = \frac{2R^2/9}{2R/3 + R/3}$$

$$\therefore R_{eq} = \frac{2R}{9}$$

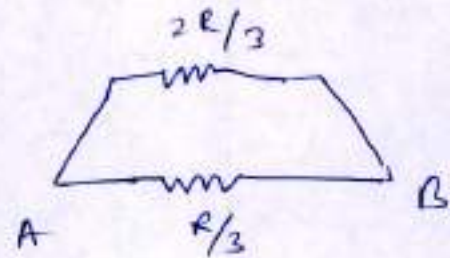

7) (d)

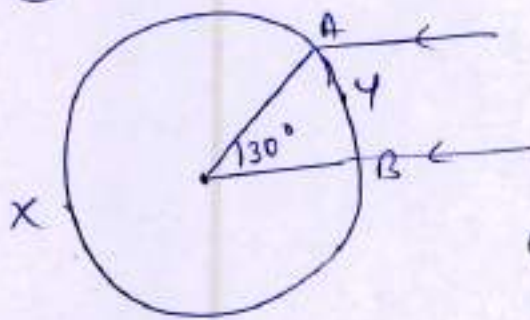

$$R_{AXB} = \frac{11}{12} \times 36 = 33 \Omega$$

$$R_{AYB} = \frac{1}{12} \times 36 = 3$$

Now R_{AXB} and R_{AYB} are in parallel.

$$\therefore R_{eq} = \frac{33 \times 3}{33 + 3}$$

$$\therefore R_{eq} = 2.75 \Omega$$

8) (d)

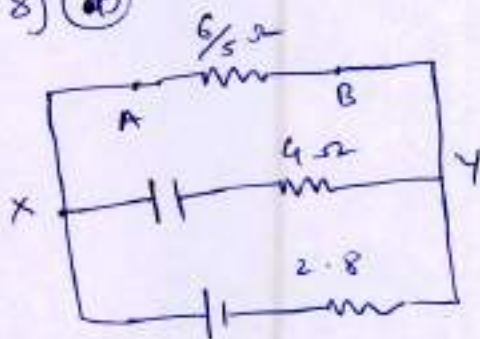

At steady state, there will be no current through branch XY.

$$\therefore 6 - (6/5 + 2.8) i = 0$$

$$\therefore 6 - 4i = 0 \Rightarrow i = \frac{3}{2} A \Rightarrow i = 1.5 A$$

$$\therefore i_{2.8} = 1.5 \times \frac{3}{5} = 0.9 A$$

9) (c)

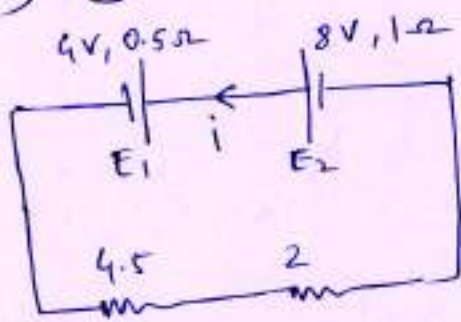

$$\therefore 8 - 1i - 4 - 0.5i - 4.5i - 2i = 0$$

$$\therefore 4 - 8i = 0$$

$$\therefore i = 0.5 \text{ A}$$

$$\therefore \text{p.d across } E_1 = 4 + 0.5 \times 0.5$$

$$\therefore \text{p.d across } E_1 = \boxed{4.25 \text{ V}}$$

$$\begin{aligned} \text{p.d across } E_2 &= 8 - 1 \times 0.5 \\ &= 7.5 \text{ V} \end{aligned}$$

10) (c)

$$V = iR = \frac{ER}{r+R}$$

$$\text{so when } R \rightarrow 0 \Rightarrow V = \frac{ER}{r} \rightarrow 0$$

$$\text{when } R \rightarrow \infty \Rightarrow V = \frac{ER}{R} \rightarrow E$$

11) (c)

$$\alpha = \frac{1}{R} \frac{dR}{dt} = \frac{R_0(\alpha + 2\beta t)}{R_0(1 + \alpha t + \beta t^2)}$$

$$\therefore \boxed{\alpha = \frac{\alpha + 2\beta t}{(1 + \alpha t + \beta t^2)}}$$

13) (A)

voltage at A is maximum and it decreases as we move towards B.

Suppose null point for E_2 is at c'

$$\therefore Bc' > Bc$$

$\therefore c'$ should be left to c .

14)

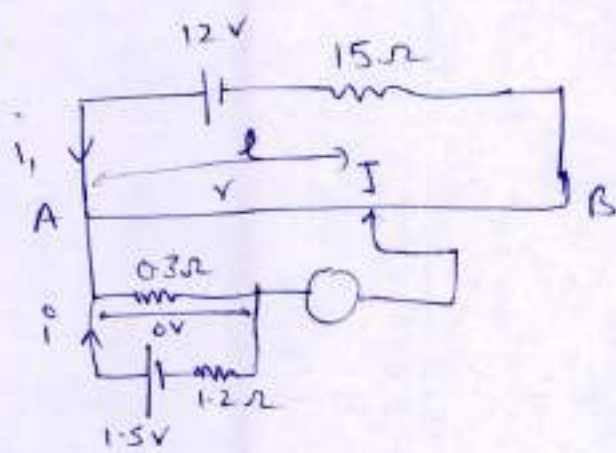

$$1.5 - i(0.3 + 1.2) = 0$$

$$\therefore \boxed{i = 1A}$$

$$\therefore 0V = i \times 0.3 \times$$

$$= 0.3V$$

$$\therefore 12 - (15 + 10)i_1 = 0$$

$$\therefore i_1 = \frac{12}{25}$$

$$\therefore i_1 \times y = 0V = 0.3$$

$$\therefore \frac{12}{25} y = 0.3$$

$$y = \frac{25 \times 0.3}{12}$$

$$\therefore y = 0.625 \Omega$$

$$\therefore \frac{l}{y} = \frac{100}{9.10} \Rightarrow l = 10 \times y \text{ cm}$$

$$\therefore \boxed{l = 6.25 \text{ cm}}$$

$$15) \text{ Potential gradient} = \frac{i \times 10}{1} = \frac{120}{25} \Omega/m$$

$$= 4.8 \Omega/m$$

16) (d)

$$10 - (9+1)i = 0 \Rightarrow i = 1A$$

$$\therefore V_{AB} = 9 \times 1 = 9V$$

$$\therefore \frac{x}{l} = \frac{5}{9}$$

$$\therefore x = \frac{5}{9} \times 100 \text{ cm}$$

$$\therefore \boxed{x = 55.55 \text{ cm}}$$

17) (c)

$$\text{New length of potentiometer} = l + \frac{l}{2} = \frac{3l}{2}$$

$$\therefore d = \frac{l}{5} \times \frac{3l}{2}$$

$$\therefore \boxed{d = \frac{3l}{10}}$$

18) (b)

$$R_{eq} = R_1 + R_2$$

$$R_{eq} = 104(1 + 3 \times 10^{-4} dt) + R(1 + 5.2 \times 10^{-4} dt)$$

Now R_{eq} does not change with temperature, so terms with dt should not be there.

$$\therefore 104 - 104 \times 3 \times 10^{-4} dt + R \times 5.2 \times 10^{-4} dt = 0$$

$$\therefore 5.2R = 104 \times 3$$

$$\therefore R = \frac{104 \times 3}{5.2}$$

$$\therefore \boxed{R = 60 \Omega}$$

19) (d)

$$R = \frac{V}{i} = \frac{dV}{di} = \text{slope}$$

* slope at B is higher than at C.

$$\therefore R_B > R_C$$

20] (c)

Will not depend on the value of R as the current will not flow

21] (b)

$$E = 250 \text{ z}$$

$$E - ir = 200 \text{ z}$$

$$\therefore E - \frac{E r}{(r+R)} = 200 \text{ z} \Rightarrow E \left(\frac{r+2-r}{r+2} \right) = 200 \text{ z}$$

$$\therefore 250 \text{ z} \left(\frac{2}{r+2} \right) = 200 \text{ z}$$

$$\therefore \frac{2}{r+2} = \frac{4}{5} \Rightarrow 10 = 4r + 8 \Rightarrow \boxed{r = 0.5 \Omega}$$

23] (a)

$$P = \frac{V^2}{R} \Rightarrow R = \frac{V^2}{P} \Rightarrow \frac{\rho l}{A} = \frac{V^2}{P}$$

$$\therefore A = \frac{\rho l P}{V^2}$$

So, for same length area (radius) is directly proportional to power.

26] (d)

$$\text{Power} \times \text{time} = mc \Delta T$$

$$\frac{i^2 R \times t}{4.18} = (\text{density} \times \text{volume}) \times 9 \times 10^{-2} \times 1025$$

$$R = \frac{\rho l}{A}$$

Solving this, we get $t = 540 \text{ s}$

27] (c)

$$R_{eq} = R_1 (1 + \alpha_1 \Delta T) + R_2 (1 + \alpha_2 \Delta T)$$

it is independent of temperature.

$$\therefore R_1 \alpha_1 \Delta T + R_2 \alpha_2 \Delta T = 0$$

$$R_1 + R_2 = 36$$

$$R_1 (4 \times 10^{-3}) + 36 (36 - R_1) (-0.5 \times 10^{-3}) = 0$$

$$\therefore 4R_1 - 18 + \frac{R_1}{2} = 0$$

$$\therefore \frac{9R_1}{2} = 18$$

$$\therefore \boxed{R_1 = 4}$$

$$\therefore \boxed{R_2 = 32}$$

28] (b)

$$R_a = 60(1 + 4 \times 10^{-3} dT)$$

$$R_c = 40(1 - 0.5 \times 10^{-3} dT)$$

$$R_{eq} = \frac{R_a R_c}{R_a + R_c} = \frac{(60 + 240 \times 10^{-3} dT)(40 - 20 \times 10^{-3} dT)}{100 + (240 - 20) \times 10^{-3} dT}$$

$$\therefore R_{eq} = \frac{2400 + (9600 - 1200) \times 10^{-3} dT - 4800 \times 10^{-3} (dT)^2}{100 + 220 \times 10^{-3} dT}$$

$$\therefore R_{eq} = \frac{2400 + 8400 \times 10^{-3} dT - 4800 \times 10^{-3} (dT)^2}{100 + 0.22 dT}$$

$$\therefore R_{eq} = \frac{2400 + 8.4 dT - 4.8 (dT)^2}{100 + 0.22 dT}$$

Now, if $\frac{dR_{eq}}{dT}$ is negative the R_{eq} will decrease

w.r.t temperature

$$\frac{d(R_{eq})}{dT} = \frac{(100 + 0.22 dT)(-9.6(dT) + 8.4) - 0.22(2400 + 8.4 dT - 4.8 dT^2)}{(100 + 0.22 dT)^2}$$

$$\therefore \frac{d(R_{eq})}{dT} < 0$$

$\therefore R_{eq}$ will decrease with rise in temperature

29) (c)

$$E_{eq} = nE$$

$$r_{eq} = \frac{nR}{m}$$

Now $i = 1.5 \text{ A}$, $E = 1.5$

$$\therefore nE - i \left(\frac{nR}{m} + 30 \right) = 0$$

$$\therefore 1.5n - \frac{1.5n}{m} = 45$$

$$\therefore n \left(1 - \frac{1}{m} \right) = 30$$

$$\therefore \frac{n(m-1)}{m} = 30$$

$$m_{min} = 2$$

$$\therefore \text{for } m=2, \frac{n \times 1}{2} = 30 \Rightarrow n = 60$$

\therefore Minimum number of cells = $mn = 120$

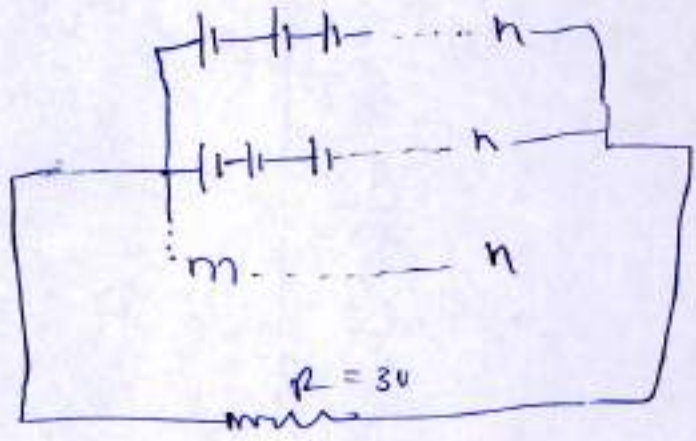

30) (c)

2Ω and 6Ω are in parallel

$$\therefore R_{eq} = \frac{2 \times 6}{6 + 2} = \frac{12}{8} = \frac{3}{2} = 1.5 \Omega$$

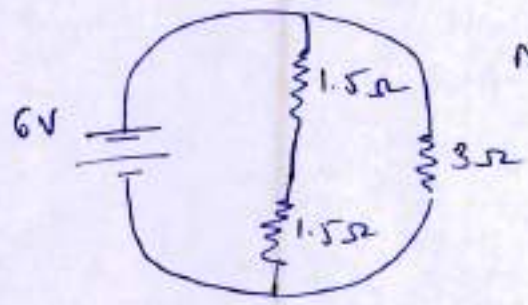

Now, the two 1.5Ω are in series

$$\therefore R_{eq} = 1.5 + 1.5 = 3 \Omega$$

Now, the 3Ω resistances are in parallel.

$$\therefore R_{eq} = \frac{3 \times 3}{3 + 3} = \frac{3}{2} = 1.5 \Omega$$

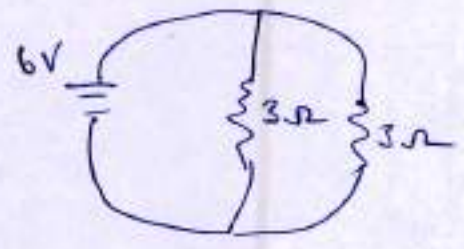

$$\therefore 6 - 1.5i = 0$$

$$\therefore i = 4 \text{ A}$$

31] (a)

Let the resistances be x and y

$$\therefore S = x + y$$

$$P = \frac{xy}{x+y}$$

$$\therefore P = \frac{xy(x+y)}{(x+y)^2} \Rightarrow P = \frac{xy}{(x+y)^2} S$$

$$\therefore S = \frac{(x+y)^2}{xy} P$$

$$\therefore n = \frac{(x+y)^2}{xy}$$

We know, A.M \geq G.M \therefore For x and y

$$\frac{x+y}{2} \geq \sqrt{xy} \Rightarrow \frac{(x+y)^2}{4} \geq xy$$

$$\therefore \frac{(x+y)^2}{xy} \geq 4$$

$$\therefore \boxed{n \geq 4}$$

 \therefore minimum possible value = 4

32] (a)

Let emf of battery be E'

$$100z = E$$

$$30z = E'$$

(where z = potential drop per unit length)

$$\therefore \frac{100z}{30z} = \frac{E}{E'}$$

$$\therefore \boxed{E' = \frac{30E}{100}}$$

23] (a)

Voltmeter should be connected in parallel and ammeter in series

34] (b)

27

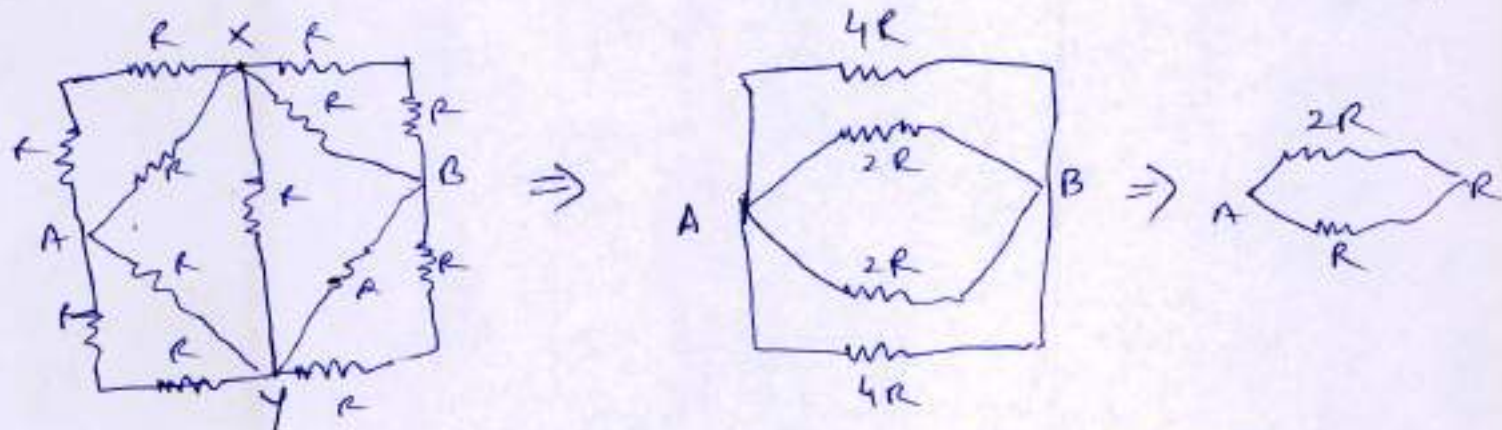

Points X and Y will be at same potential. So no current through branch XY

$$\therefore R_{eq} = \frac{2R \times R}{2R + R}$$

$$\therefore R_{eq} = \frac{2R}{3}$$

35] (a)

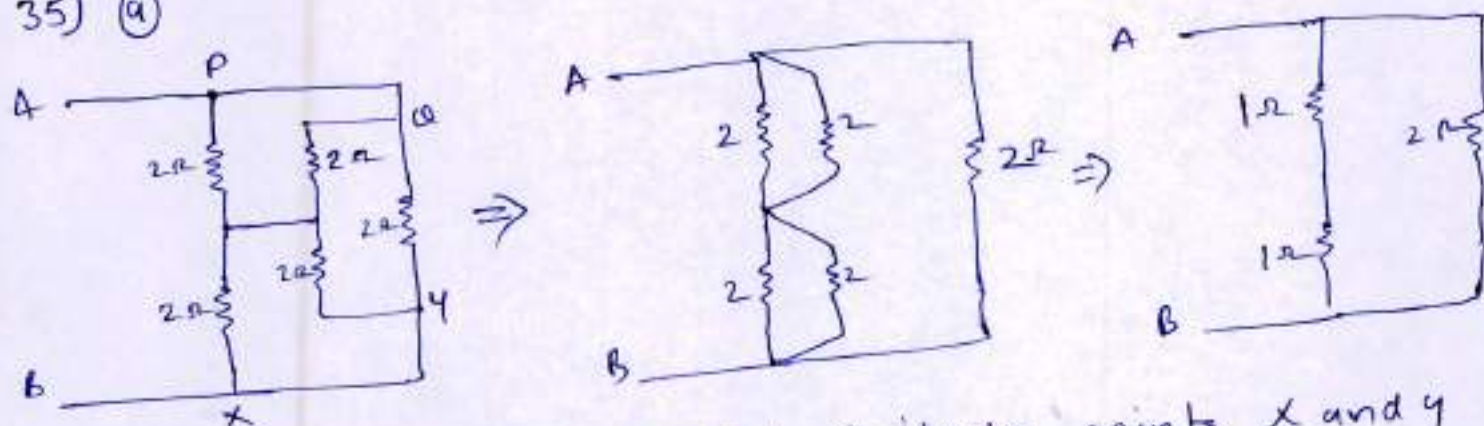

Points P, Q are equipotential. Similarly points X and Y are equipotential.

$$\therefore R_{eq} = \frac{2 \times 2}{2 + 2} \Rightarrow R_{eq} = 1\Omega$$

36] (b)

$$10i = 50z ; (10 + R)i = 60z \quad (z = \text{potential drop per unit length})$$

$$\therefore Ri = (60 - 50)z$$

$$\therefore \frac{10}{R} = \frac{50}{10} \Rightarrow R = \frac{10}{5} \Rightarrow R = 2\Omega$$

37] (c)

$$\text{Power stored} = Vi = 2 \times 4 = 8W$$

$$\therefore \text{in 8 batteries Power} = 8 \times 8 = 64W$$

38) (c)

$$\frac{(115)^2}{R} = 500 \quad ; \quad \frac{(110)^2}{R'} = P'$$

$$\therefore \frac{(115)^2}{(110)^2} = \frac{500}{P'} \Rightarrow P' = 500 \left(\frac{110}{115}\right)^2 \Rightarrow P' = 500 \left(\frac{22}{23}\right)^2$$

$$\begin{aligned} \therefore \% \text{ change} &= \frac{500 - P'}{500} \times 100 \\ &= \frac{500 - 500 \left(\frac{22}{23}\right)^2}{500} \times 100 \\ &= \frac{529 - 484}{529} \times 100 \end{aligned}$$

$$\therefore \% \text{ change} = 8.5\%$$

39) (a)

40) (c)

$$P = \frac{V^2}{R} \Rightarrow R = \frac{V^2}{P}$$

$$P = i^2 R \Rightarrow P = i^2 \frac{V^2}{P} \Rightarrow i^2 = \frac{P^2}{V^2}$$

$$\therefore i = \frac{P}{V} \quad \text{B/E}$$

Now say n bulbs are connected in parallel, so current through each branch will be $\frac{9}{n}$.

$$\therefore \frac{9}{n} = \frac{P}{V} = \frac{60}{220}$$

$$\therefore n = \frac{9 \times 220}{60}$$

$$\therefore n = 33$$

41) (a)

Current will be same.

$$\therefore \frac{Q_1}{Q_2} = \frac{i^2 \times 2}{i^2 \times 1} = \frac{2}{1}$$

42) (b)

$$m = 2 \times 4 \times 2 \times 60$$

$$m' = 2 \times 6 \times 40$$

$$\therefore \frac{m'}{m} = \frac{6 \times 40}{4 \times 2 \times 60} = \frac{1}{2}$$

$$\therefore \boxed{m' = \frac{m}{2}}$$

43) (c)

$$m = 2 A t$$

$$dm = 2 A dt$$

$$\therefore m = 2 \int A dt$$

$$\therefore m = 2 \left[\frac{1}{2} \times 10 \times 100 + 10 \times 100 + \frac{1}{2} \times 10 \times 100 \right] *$$

$$\therefore m = 2 (2000 \times 10^{-5})$$

→ Area under the curve.

$$\therefore m = 2z$$

$$\therefore \boxed{z = \frac{m}{2}}$$

Assertion And Reasoning

30

1] (d)

Both are false.

- Variation of resistivity with temperature for a typical semiconductor.

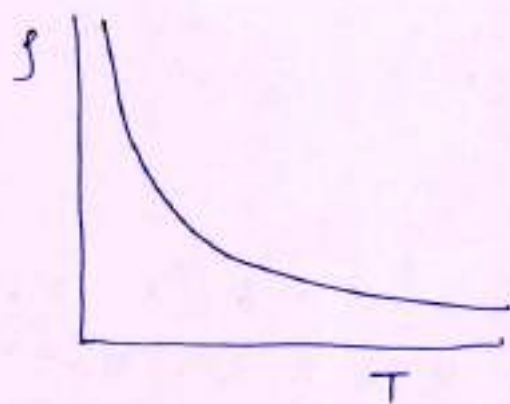

2] (d)

3] (b)

In semiconductors, the energy gap between the valence band and conduction band is lesser as compared to insulators. As the temperature increases, electrons move from valence band to conduction band. So the conductivity increases i.e. resistivity and resistance decreases. This is the reason, temperature coefficient of semiconductor is negative for semiconductors.

4] (a)

$$E - (r + R)i = 0 \Rightarrow 2 - (1+1)i = 0$$

$$\therefore i = 1 \text{ A}$$

$$V = E - ir = 2 - 1 \times 1$$

$$\therefore \boxed{V = 1 \text{ V}}$$

5] (a)

Due to the random motion of electrons, there is no net motion of electrons in any particular direction. So, current is zero.

6] (c) ³¹
The third connection is for earthing. This is used when the appliance has a metal casing to take any current away if the live wire comes in contact with the casing.

7] (b)
If the temperature increases, the average collision time decreases and so the drift velocity decreases

$$v_d = \frac{e I E}{2m}$$

$$v_d \propto I \text{ (avg collision time)}$$

8] (c)

The drift speed of electrons in a conductor is low (10^{-4} m/s approx.), yet the bulb glows instantly. This is because, when we close the circuit, the electric field is set up in the entire closed circuit instantly with the speed of electromagnetic wave which causes electron drift at every portion of the circuit.

Due to this, the current is set up in the entire circuit instantly. The current so set up does not wait for the electrons to flow from one end of the conductor to other end.

It is due to this reason, the electric bulb glows immediately when switched on.

9] (a)

Bending a wire does not change either the length or area of wire

$$R = \frac{\rho l}{A} \text{ (with } l \text{ and } A \text{ as constant, } R \propto \rho)$$

10] (c)

current in a circuit decreases with increase in resistance.

11] (a)

12] (b)

Both are true. ~~but~~ but not proper explanation

13] (a)

$$\text{Potential gradient} = \frac{V}{l}$$

\therefore Potential gradient for larger length becomes small.
and measurements can be done more accurately

14] (a)

15] (a)

Repeated.

Electric Conduction, Ohm's Law and Resistance.

1) (a)

Volume will be constant $\Rightarrow l_1 A_1 = l_2 A_2 \Rightarrow \boxed{\frac{l_1}{l_2} = \frac{A_2}{A_1}}$

$$4 = \frac{\rho l_1}{A_1} \quad ; \quad R_2 = \frac{\rho l_2}{A_2}$$

$$\therefore \frac{4}{R_2} = \frac{\rho l_1 / A_1}{\rho l_2 / A_2} = \frac{l_1}{A_1} \times \frac{A_2}{l_2} = \frac{l_1}{l_2} \times \frac{A_2}{A_1}$$

$$\therefore \frac{4}{R_2} = \frac{l_1}{l_2} \times \frac{l_1}{l_2} = \left(\frac{l_1}{l_2}\right)^2 = \left(\frac{1}{2}\right)^2$$

$$\therefore R_2 = 4 \times 4$$

$$\therefore \boxed{R_2 = 16 \Omega}$$

2) (c)

Let the density of copper be d .

$$\therefore m_1 : m_2 : m_3 = d l_1 A_1 : d l_2 A_2 : d l_3 A_3 = 5 : 3 : 1$$

$$l_1 : l_2 : l_3 = 1 : 3 : 5$$

$$\therefore A_1 : 3A_2 : 5A_3 = 5 : 3 : 1 \Rightarrow A_1 : A_2 : A_3 = 25 : 5 : 1$$

$$R_1 : R_2 : R_3 = \frac{\rho l_1}{A_1} : \frac{\rho l_2}{A_2} : \frac{\rho l_3}{A_3}$$

$$\therefore R_1 : R_2 : R_3 = \frac{l_1}{A_1} : \frac{l_2}{A_2} : \frac{l_3}{A_3}$$

$$= \frac{1}{25} : \frac{3}{5} : \frac{5}{1}$$

$$\therefore \boxed{R_1 : R_2 : R_3 = 1 : 15 : 125}$$

3) (d)

$$Vd \propto \frac{I}{A} \quad \therefore \frac{Vd_1}{Vd_2} = \frac{I/A_1}{I/A_2} = \frac{A_2}{A_1} = \frac{\frac{1}{4} \pi d_2^2}{\frac{1}{4} \pi d_1^2} = \frac{d_2^2}{d_1^2}$$

$$\therefore \frac{Vd_1}{Vd_2} = \frac{d_2^2}{d_1^2} = \frac{1}{4}$$

4) (c)

Resistivity for semiconductor decreases as the temperature is increased.

5) (d)

$$\text{Specific conductivity} = \frac{1}{\rho} = \frac{1}{\rho_m} = \rho^{-1} \text{cm}^{-1}$$

6) (d)

$$60 = 20 (1 + \alpha (500 - 20)) \Rightarrow \alpha = \frac{2}{480} = \frac{1}{240}$$

$$25 = 20 \left(1 + \frac{1}{240} dT\right) \Rightarrow \frac{1}{4} = \frac{1}{240} dT$$

$$\therefore dT = 60$$

$$\therefore T_2 - 20 = 60$$

$$\therefore \boxed{T_2 = 80^\circ\text{C}}$$

7) (b)

slope of graph will give $\frac{1}{R}$

\therefore As R ~~increases~~ increases with temperature

$\therefore \frac{1}{R}$ will decrease with temperature

\therefore slope will decrease with temperature.

\therefore lower the slope more will be temperature.

$$\therefore \boxed{T_2 > T_1}$$

8) (d)

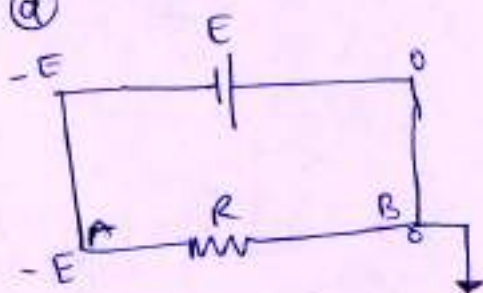

V across AB is constant i.e. E
 R is constant.

$\therefore i = \frac{V}{R}$ will be constant

9) (a)

$$V_d = \frac{eE}{2m} E$$

10) (a)

Rate of flow of electrons through every cross-section will be same as the current is always equal throughout the wire.

11) (d)

12) (b)

$$V = E - ir$$

\therefore slope = $-r$, intercept is E

13) (b)

$$\frac{V}{I} = \text{Resistance}$$

Resistance increases as temperature rises.

14) (d)

$$R = \frac{V}{i} = \frac{3.5}{0.28} = 12.5 \Omega$$

$$\therefore 12.5 = 4(1 + 425\alpha)$$

$$\therefore \boxed{\alpha = 5 \times 10^{-3} \text{ K}^{-1}}$$

15) (a)

$$i = \frac{dq}{dt} \Rightarrow dq = i dt \Rightarrow q = \int i dt$$

$$\therefore q = \int_0^2 (3t^2 + 2t + 5) dt$$

$$\therefore q = t^3 + t^2 + 5t \Big|_0^2$$

$$\therefore q = 8 + 4 + 10$$

$$\therefore \boxed{q = 22 \text{ C}}$$

16] (b)

36

Volume will be constant $\Rightarrow l_1 A_1 = l_2 A_2$

$$\therefore l_1 \pi r_1^2 = l_2 \pi r_2^2$$

$$\therefore l_1 r_1^2 = l_2 r_2^2$$

$$\therefore l_1 r_1^2 = 1.1 l_1 r_2^2 \Rightarrow \frac{r_1^2}{r_2^2} = 1.1$$

$$\therefore \frac{R_1}{R_2} = \frac{\rho l_1 / A_1}{\rho l_2 / A_2} = \frac{l_1}{A_1} \times \frac{A_2}{l_2} = \frac{l_1}{l_2} \times \frac{\pi r_2^2}{\pi r_1^2} = \frac{l_1}{l_2} \times \frac{r_2^2}{r_1^2}$$

$$\therefore \frac{R_1}{R_2} = \frac{1}{1.1} \times \frac{1}{1.1} \Rightarrow \boxed{R_2 = 1.21 R_1}$$

Specific resistance will be same.

17] (d)

18] (c)

$$i = n e A v_d \Rightarrow v_d = \frac{i}{n e A} = \frac{40}{10^{29} \times 1.6 \times 10^{-19} \times 10^{-6}}$$

$$\therefore v_d = \frac{40}{1.6 \times 10^4} = 2.5 \times 10^{-3} \text{ m/s.}$$

19] (d)

The drift velocity decreases with increase in temperature and the thermal velocity increases.

20] (b)

$$R_a = \rho_a \frac{l_a}{A_a} ; R_c = \rho_c \frac{l_c}{A_c}$$

$$\frac{R_a}{R_c} = \frac{\rho_a l_a / A_a}{\rho_c l_c / A_c} = \frac{\rho_a}{\rho_c} \frac{A_c}{A_a} \Rightarrow 1 = 2 \frac{A_c}{A_a} \quad (\because \rho_c = \frac{3\rho_a}{2})$$

$$\therefore \frac{A_a}{A_c} = 2$$

$$\frac{m_a}{m_c} = \frac{\rho_a l_a A_a}{\rho_c l_c A_c} = \frac{\rho_a A_a}{\rho_c A_c} = \frac{1}{3} \times 2$$

$$\therefore \boxed{\frac{m_a}{m_c} = \frac{2}{3}}$$

21) (b)

$$\frac{j_1}{j_2} = \frac{i/A_1}{i/A_2} = \frac{A_2}{A_1} = \frac{\pi r_2^2}{\pi r_1^2} = \frac{9}{1}$$

22) (b)

$$R_1 = \frac{\rho l}{A} \quad ; \quad R_2 = \frac{\rho 2l}{\pi (2r)^2} = \frac{2\rho l}{4\pi r^2} = \frac{1}{2} \frac{\rho l}{A}$$

$$\therefore R_2 = \frac{R_1}{2}$$

24) (a)

If V is doubled, i will be doubled ($\because V = iR$)

$$\text{And } v_d = \frac{i}{nrA}$$

\therefore If i is doubled, v_d will also be doubled.

25) (d)

$$5 = R_0 (1 + \alpha \times 50) \quad - (1) \quad (R_0 = \text{Resistance at } 0^\circ\text{C})$$

$$6 = R_0 (1 + \alpha \times 100) \quad - (2)$$

Dividing (2) by (1),

$$\frac{6}{5} = \frac{1 + 100\alpha}{1 + 50\alpha} \Rightarrow 6 + 300\alpha = 5 + 500\alpha$$

$$\therefore \alpha = \frac{1}{200}$$

$$\text{Putting in eq (1)} \Rightarrow 5 = R_0 \left(1 + \frac{1}{200} \times 50\right)$$

$$5 = \frac{5}{4} R_0 \Rightarrow \boxed{R_0 = 4 \Omega}$$

26) (a)

$$R_0 = \frac{\rho l}{A} \Rightarrow 5 = \frac{\rho l}{\pi (9)^2}$$

$$R_2 = \frac{\rho 6l}{\pi (3)^2}$$

$$\therefore \frac{5}{R_2} = \frac{1}{(9)^2} \cdot \frac{(3)^2}{6l} = \frac{1}{9 \times 6} \Rightarrow R_2 = 9 \times 6 \times 5$$

$$\therefore \boxed{R_2 = 270 \Omega}$$

27] (c)

$$V_d = \frac{i}{neA} = \frac{1.1}{n \times 1.6 \times 10^{-19} \times \pi \times \left(\frac{1}{2}\right)^2}$$

$$\text{density} = 9 \text{ g cm}^{-3} = 9 \times 10^{-3} \text{ g mm}^{-3}$$

$$\therefore n = \frac{9 \times 10^{-3} \times \text{Volume}}{63} \times NA$$

$$\therefore n = \frac{9 \times 10^{-3} \times \pi \times \left(\frac{1}{2}\right)^2 \times 1}{63} \times 6.023 \times 10^{23}$$

$$\therefore n = 6.75 \times 10^{19}$$

$$\therefore V_d = \frac{1.1}{6.75 \times 10^{19} \times 1.6 \times 10^{-19} \times \left(\frac{3.14}{4}\right)}$$

$$\therefore \boxed{V_d = 0.1 \text{ mm s}^{-1}}$$

28] (c)

$$R \propto \frac{1}{R} \quad f(t) = f_0 (1 + \alpha \Delta T) \Rightarrow f_0 + 2 \times 10^{-8} = f_0 (1 + 50 \times 0.0004)$$

$$\therefore \frac{2 \times 10^{-8}}{f_0} = 2 \times 10^{-2} \Rightarrow f_0 = \frac{2 \times 10^{-8}}{2 \times 10^{-2}}$$

$$\therefore \boxed{f_0 = 10^{-6} = 100 \times 10^{-8}}$$

29] (d)

Combination of Resistances

1) (b)

$$i^2 R = 36$$

$$\therefore i^2 = \frac{36}{9} \Rightarrow i = 2 \text{ A}$$

$$\therefore 9 \times 2 = 6 \times i'$$

$$\therefore i' = 3 \text{ A}$$

$$\therefore i = 2 + i' = 2 + 3 = 5 \text{ A}$$

$$\therefore V_{2\Omega} = iR = 5 \times 2 = 10 \text{ V}$$

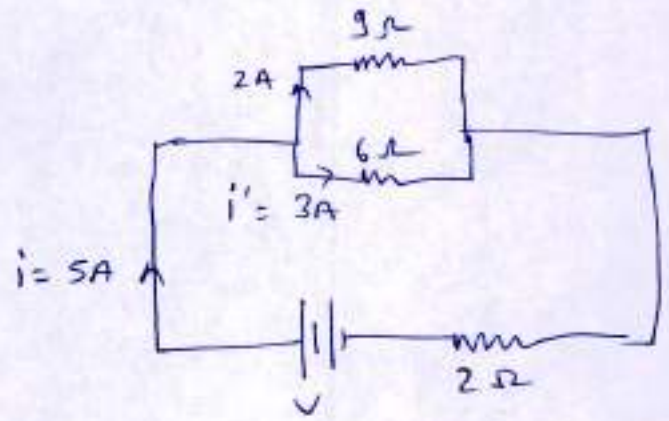

2) (d)

There will be no current through branch CD

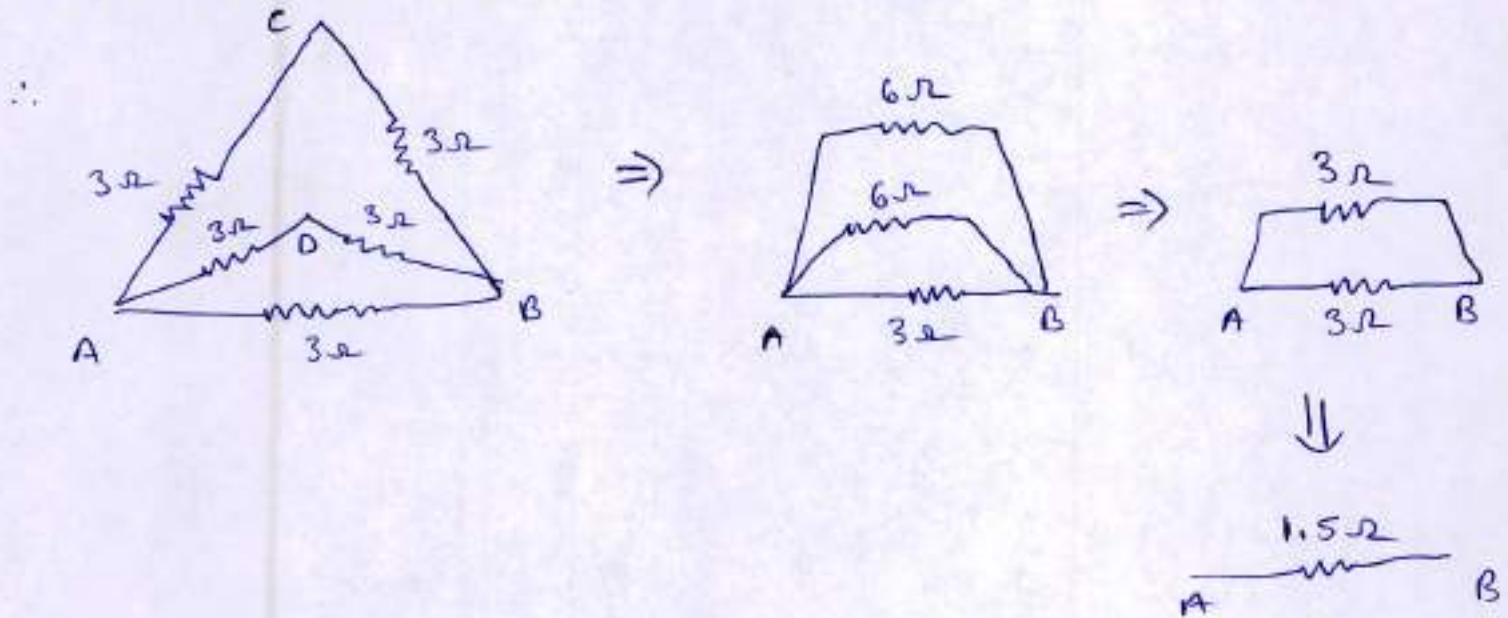

3) (d)

max power when $r = R$

$$\therefore P_{\max} = i^2 R = \left(\frac{E}{R+r}\right)^2 \cdot R = \frac{E^2}{4R}$$

4) (b)

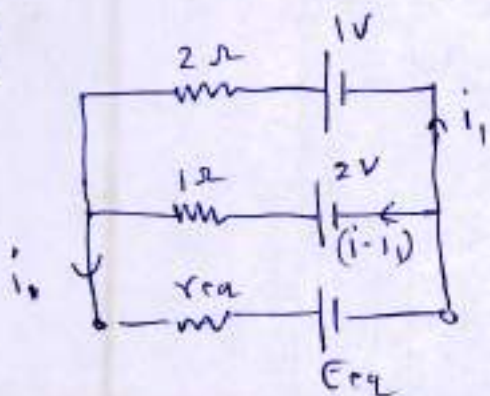

$$r_{eq} = \frac{2 \times 1}{2 + 1} = \frac{2}{3}$$

$$\therefore E_{eq} - \frac{2}{3}i = 1 - 2i_1 = 2 - (i - i_1)$$

$$\therefore 1 - 2i_1 = 2 - i + i_1$$

$$\therefore i = 3i_1 + 1 \quad \text{--- (1)}$$

Now, $E_{eq} - \frac{2}{3}i = 1 - 2i_1$

$$\therefore E_{eq} - \frac{2}{3}(3i_1 + 1) = 1 - 2i_1$$

$$\therefore E_{eq} - 2i_1 - \frac{2}{3} = 1 - 2i_1$$

$$\therefore E_{eq} - \frac{2}{3} = 1$$

$$\therefore E_{eq} = 1 + \frac{2}{3}$$

$$\therefore E_{eq} = \frac{5}{3} \text{ V}$$

5) (c)

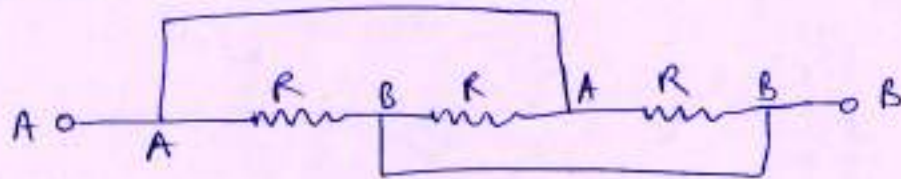

⇓

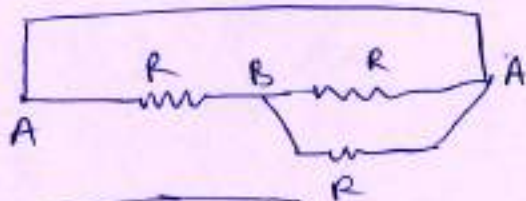

⇒

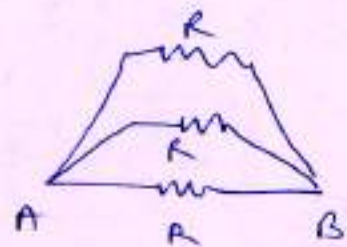

$$\therefore R_{eq} = \frac{R}{3}$$

6) (b)

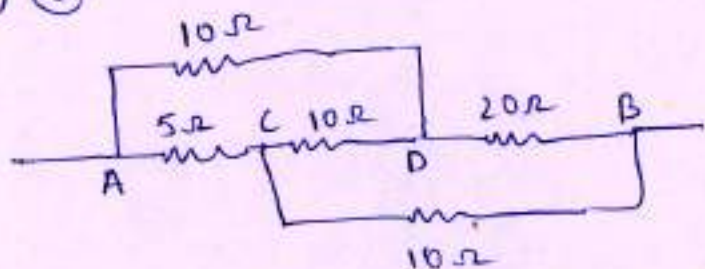

⇒

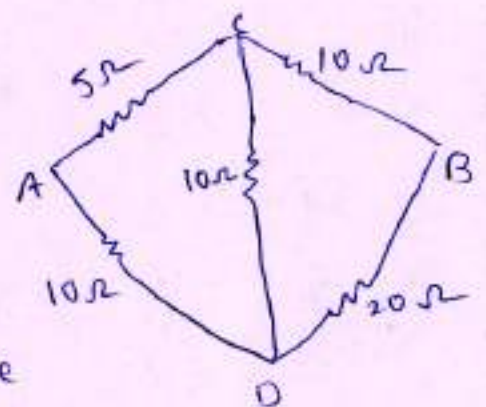

so, its a balanced wheatstone bridge

$$\therefore R_{eq} = \frac{15 \times 30}{15 + 30} = 10 \Omega$$

$$\therefore 5 - 10i = 0 \Rightarrow i = 0.5 \text{ A}$$

7) (a)

There will be no current through OB and OD as B and D will be at same potential, as the structure is symmetrical around AC .

So, the structure now becomes,

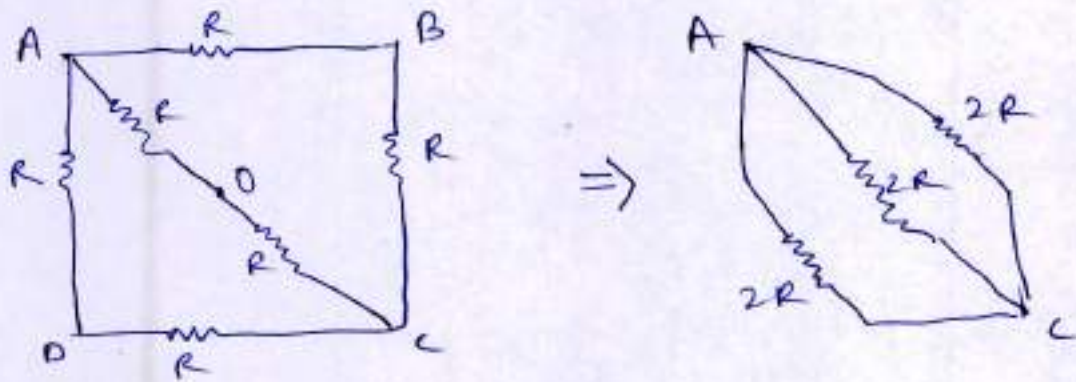

$$\therefore R + q = \frac{2R}{3}$$

8) (c)

$$5 - 2 - (10 + 20)i = 0 \Rightarrow 3 = 30i$$

$$\therefore i = 0.1 \text{ A}$$

9) (e)

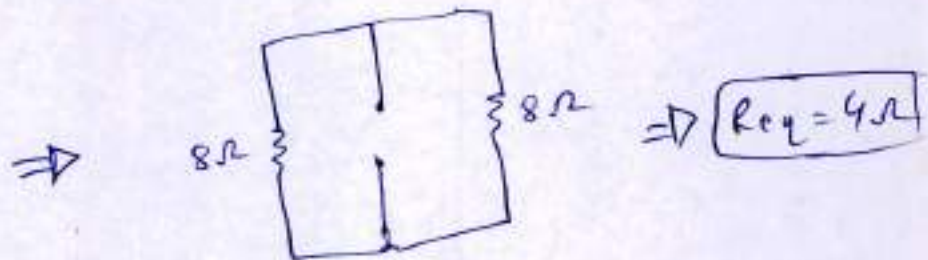
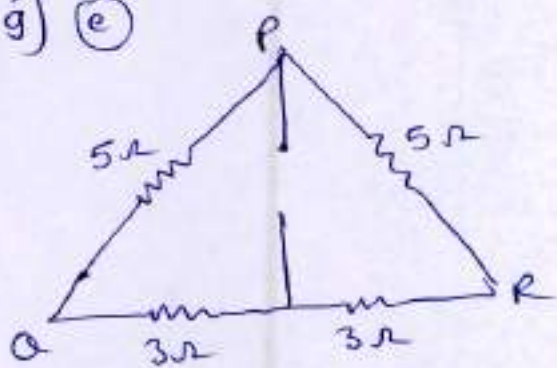

10) (b)

At steady state no current through the arm with capacitor.

$$\therefore E - (r + R_1)i = 0 \Rightarrow i = \frac{E}{r + R_1}$$

$$\therefore \frac{q}{C} = \frac{ER_1}{(r + R_1)} \Rightarrow q = \frac{CE R_1}{(r + R_1)}$$

11) (b)

Repeated question.

12) (c)

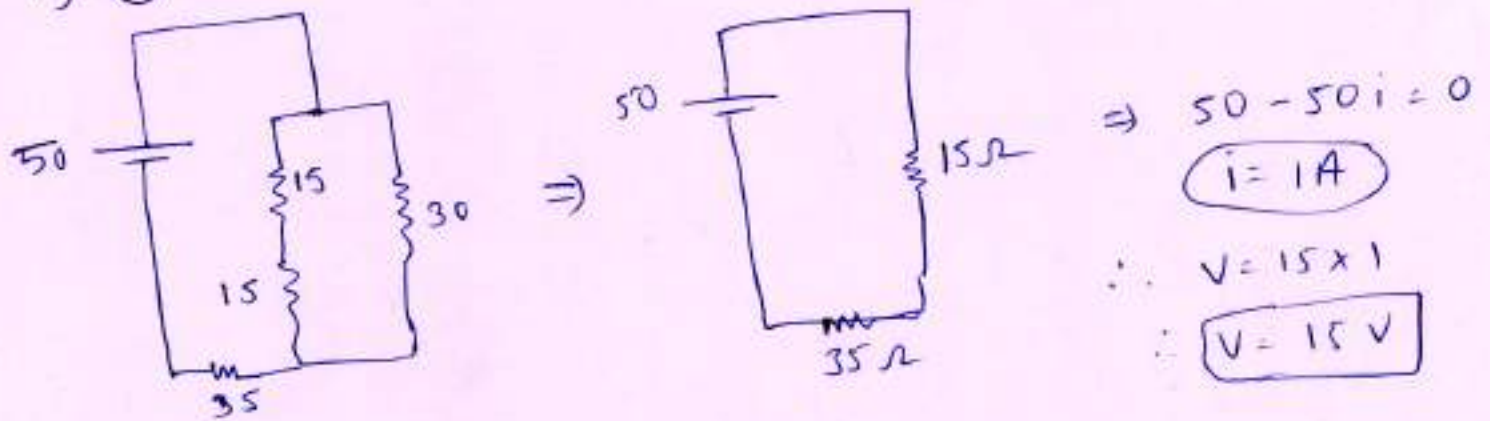

13) (b)

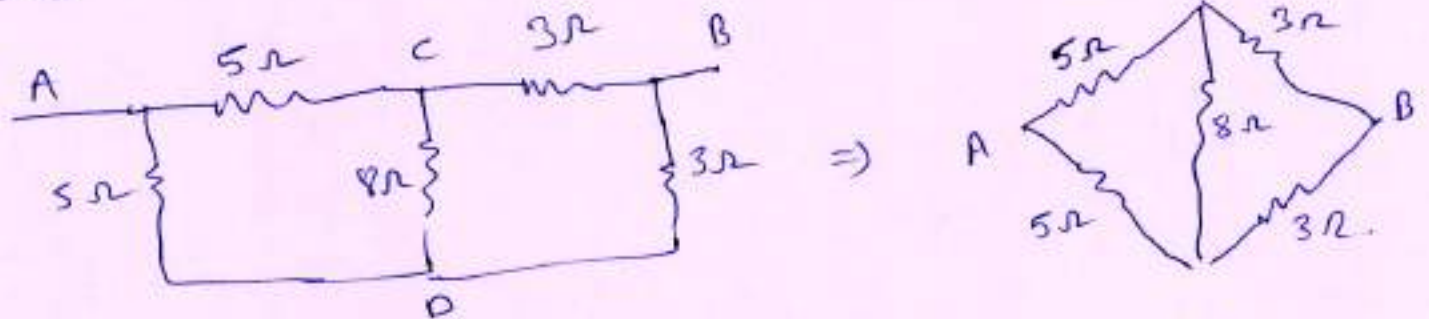

It's a balanced wheatstone bridge
 So, no current will flow through (D)

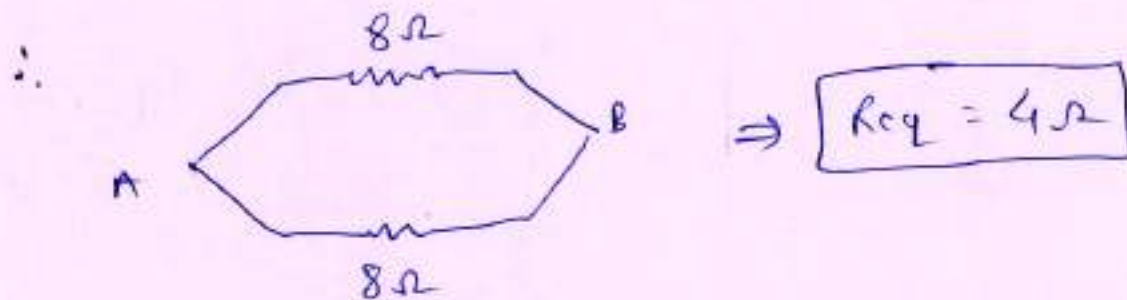

14) (b)

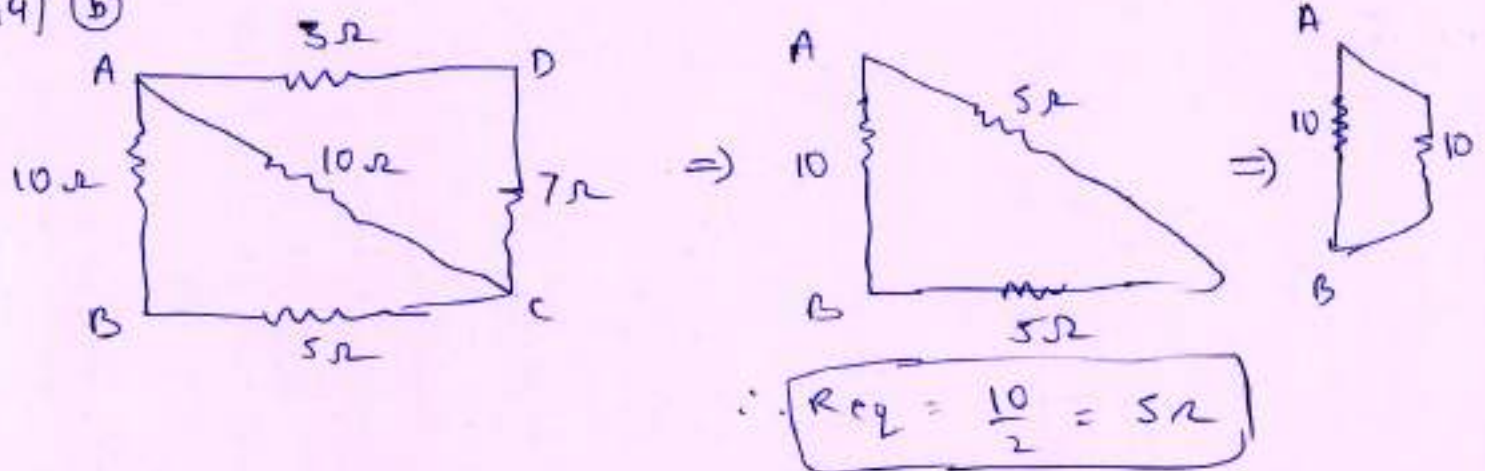

15] (c)

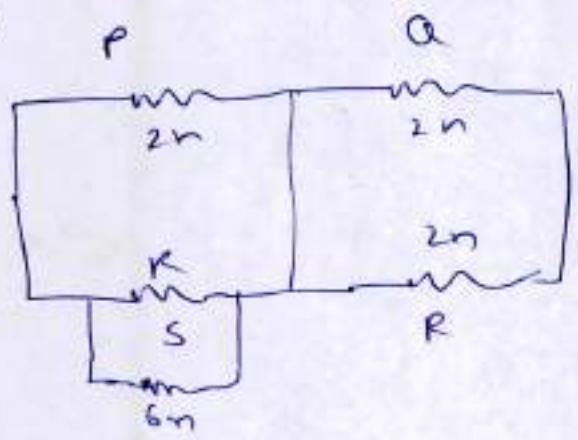

Eq of R and S

$$R_{eq} = \frac{6nR}{6n+R} = 2n$$

$$\therefore 6nR = 12n^2 + 2nR$$

$$\therefore 6R = 12n + 2R$$

$$4R = 12n$$

$$R = 3n$$

16] (d)

$$48 - 300i = 0 \Rightarrow i = \frac{48}{300} = 0.16 A$$

$$\therefore V_{ro} = 20 \times 0.16$$

$$\therefore V_{ro} = 3.2 V$$

17] (d)

Current through 4Ω resistor = 1A

$$\therefore \text{Current in aux circuit} = \frac{7}{3} \times 1 = \frac{7}{3} A$$

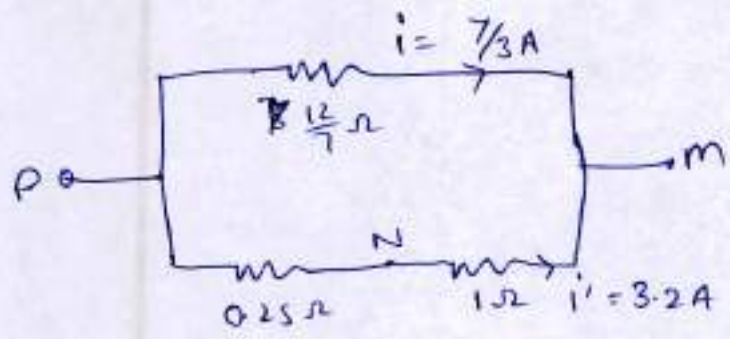

$$\therefore \frac{12}{7} \times \frac{7}{3} = (1.25)i'$$

$$\therefore 4 = \frac{5}{4} i'$$

$$\therefore i' = \frac{16}{5} = 3.2 A$$

$$\therefore V_{MN} = 1 \times i' = 3.2 V$$

19] (b)

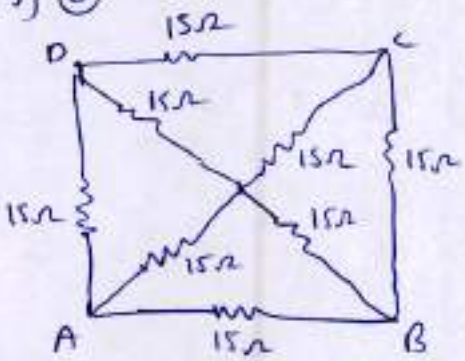

⇒

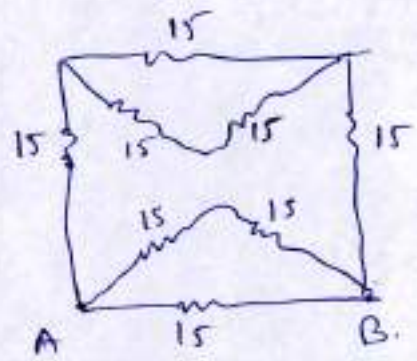

⇒

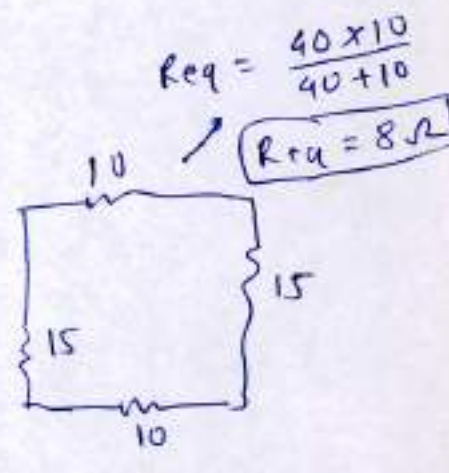

$$R_{eq} = \frac{40 \times 10}{40 + 10}$$

$$R_{eq} = 8 \Omega$$

21] (a)

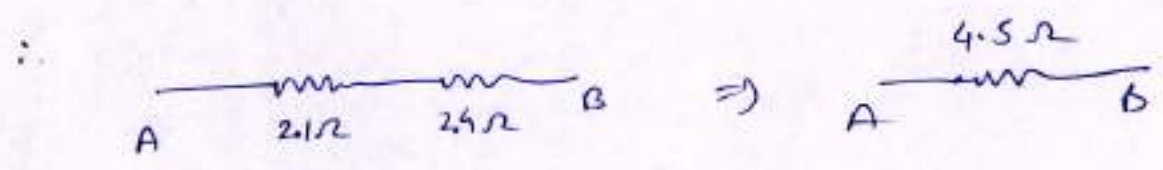
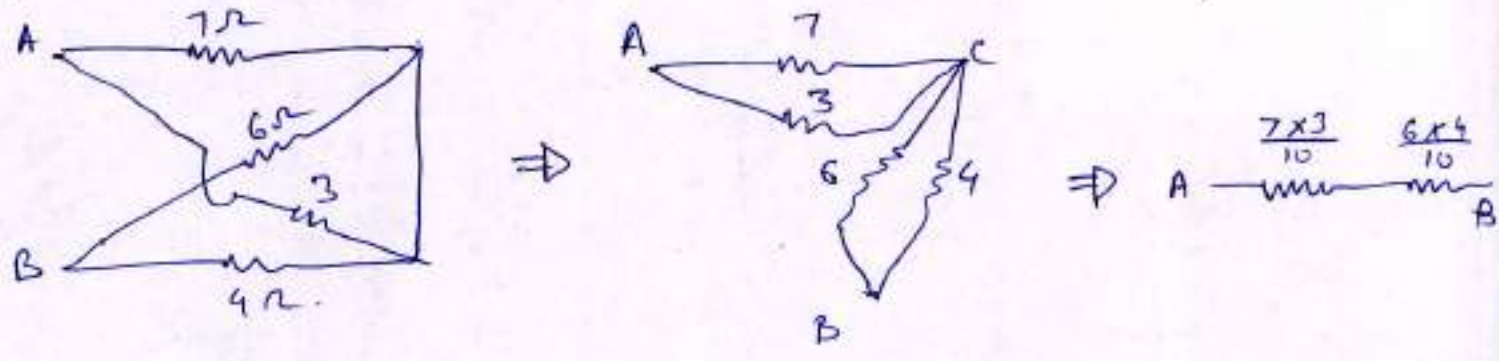

22] (c)

No current will flow through branch CD

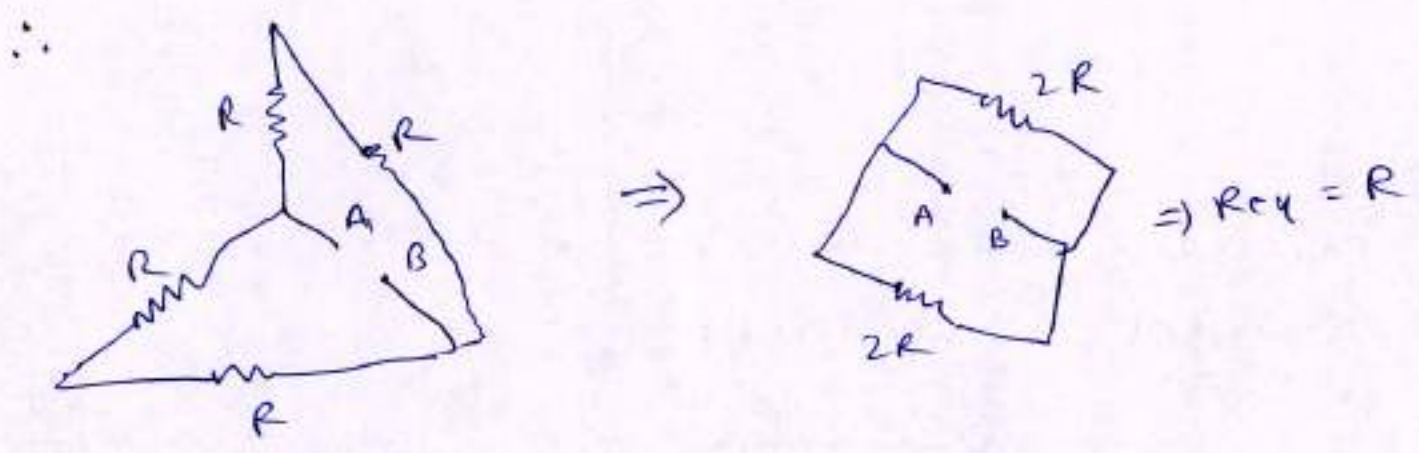

∴ $i = \frac{V}{R}$

∴ Current through AFCEB = $\frac{i}{2} = \frac{V}{2R}$

23] (b)

$R_{eq} = R + \frac{4}{3}R = \frac{7R}{3}$

∴ $E - \frac{7R}{3}i = 0 \Rightarrow i = \frac{3E}{7R}$

∴ p.d across $2R = iR_{eq} = \frac{3E}{7R} \times \frac{4R}{3}$

∴ $p.d = \frac{4E}{7}$

24) (a)

No current will flow through BH, CH, DH, EH, FH, and GH.

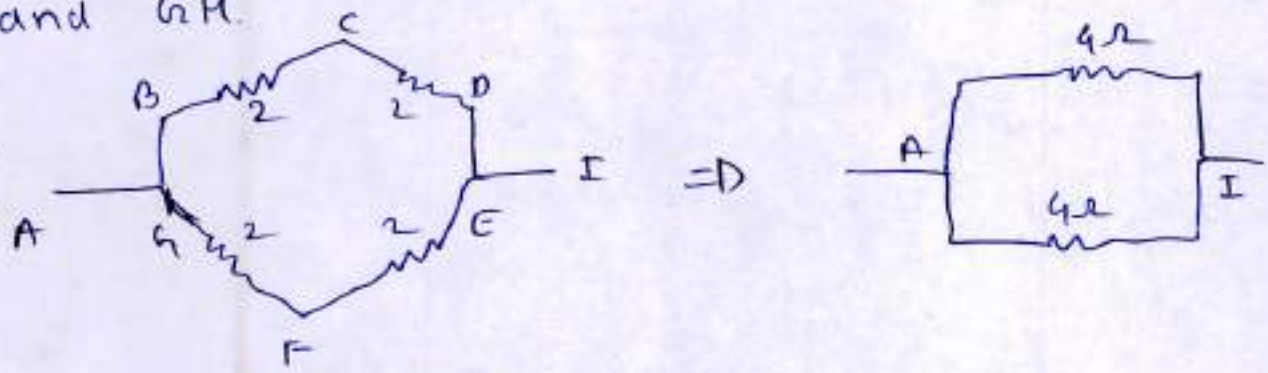

$R_{eq} = 2\Omega$

25) (d)

$R_{max} = nR$

$R_{min} = R/n$

$\Rightarrow \frac{R_{min}}{R_{max}} = \frac{R/n}{nR} = \frac{1}{n^2}$

26) (d)

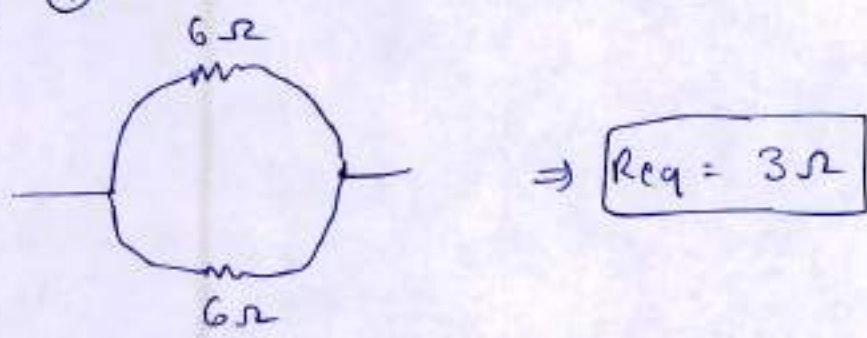

27) (c)

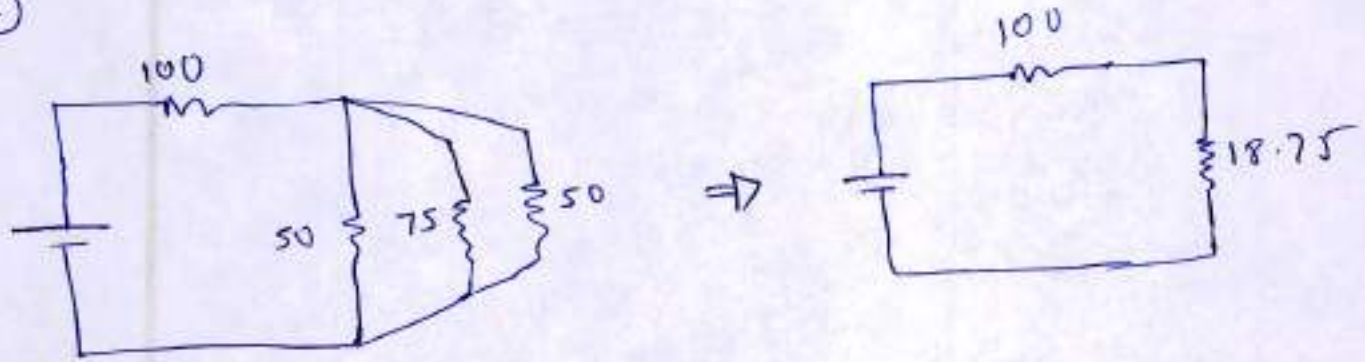

$\therefore R_{eq} = 100 + 18.75$

$R_{eq} = 118.75$

46

Kirchhoff Law, Cells and their Combinations

1) (d)

$$P_{km} = \frac{v^2}{R} = \frac{64}{0.5} = 128 \text{ W}$$

$$\therefore P_{\text{total loss}} = 150 \times 128 = 19.2 \text{ kW}$$

2) (c)

$$2.1 - 0.2(10+r) = 0 \Rightarrow 2.1 = 2 + 0.2r$$

$$\therefore r = \frac{1}{2} = 0.5 \Omega$$

3) (c)

$$\frac{10}{30} = \frac{30}{90} \quad \therefore \text{The bridge is balanced.}$$

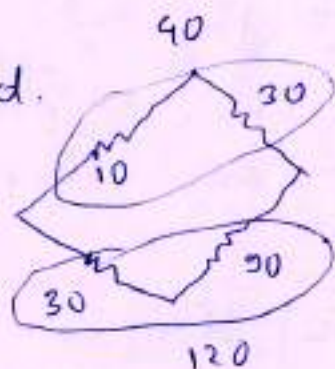

$$\therefore R_{eq} = \frac{40 \times 120}{40 + 120} = 30 \Omega$$

$$\therefore 7 - (30 + 5)i = 0$$

$$\therefore i = \frac{7}{35} = \frac{1}{5} = 0.2 \text{ A}$$

4) (a)

$$E = 2(2+r) \Rightarrow 1 = \frac{2(2+r)}{0.5(9+r)}$$

$$E = 0.5(9+r)$$

$$\therefore 9+r = 4(2+r)$$

$$\therefore 9+r = 8+4r \Rightarrow 3r = 1 \Rightarrow r = \frac{1}{3} \Omega$$

5) (b)

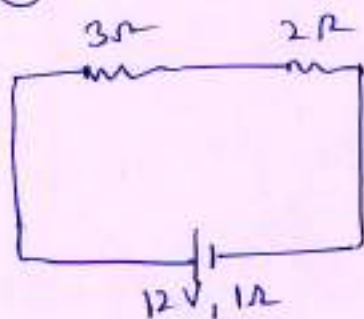

$$\therefore 12 - 6i = 0$$

$$\therefore i = 2 \text{ A}$$

$$\therefore i_1 + i_2 = 2 \text{ A}$$

$$\frac{i_1}{12} = \frac{4}{12} = \frac{1}{3} \Rightarrow i_2 = 3i_1$$

$$\therefore i_1 = 0.5 \text{ A}; i_2 = 1.5 \text{ A}$$

7) (d)

$$E = I_1(R_1 + r) \Rightarrow I_1(R_1 + r) = I_2(R_2 + r)$$

$$E = I_2(R_2 + r) \quad \therefore I_1 R_1 + I_1 r = I_2 R_2 + I_2 r$$

$$\therefore r(I_1 - I_2) = I_2 R_2 - I_1 R_1$$

$$\therefore r = \frac{I_2 R_2 - I_1 R_1}{I_1 - I_2}$$

8) (c)

$$3 - (20 + 10)i = 0 \Rightarrow i = 0.1 \text{ A}$$

$$\therefore \text{Potential drop across wire} = 0.1 \times 20 = 2 \text{ V}$$

9) (d)

At steady state, there will be no current flowing through the branch with capacitor.

$$\therefore 2.5 - (1 + 1 + 0.5)i = 0$$

$$\therefore i = 1 \text{ A}$$

$$\therefore V_{AB} = 2 \times i = 2 \times 1$$

$$\therefore V_{AB} = 2 \text{ V}$$

$$\therefore q = CV = 5 \mu\text{F} \times 2 \text{ V}$$

$$\therefore q = 10 \mu\text{C}$$

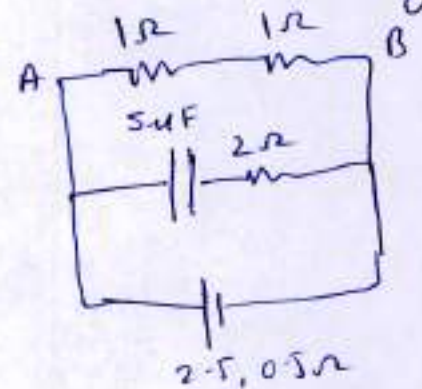

10) (d)

$$2.1 - (0.05 + 0.02)i = 0$$

$$\therefore i = 30 \text{ A}$$

$$\therefore i^2 R t = m c d T$$

$$\therefore \frac{900 \times 0.02 \times 5}{4.18} = 1 \times 0.1 \times d T$$

$$\therefore d T = 214^\circ\text{C}$$

11) B (b)

$$R \rightarrow 0 \Rightarrow E - iR = 0 \Rightarrow i \rightarrow \frac{E}{R}$$

$$V = E - iR \rightarrow 0$$

12) C

$$50 = E - 11r$$

$$60 = E - r$$

$$10 = 10r \Rightarrow r = 1$$

$$\therefore E = 61V$$

14) (b)

$$q = EC(1 - e^{-t/\tau})$$

$$\therefore C \times 300 = 400 \times C(1 - e^{-\frac{t}{0.3}})$$

$$\therefore \frac{3}{4} - 1 = -e^{-\frac{t}{0.3}}$$

$$\therefore -\frac{1}{4} = -e^{-\frac{t}{0.3}} \Rightarrow -0.602 = -\frac{t}{0.3} \log 10^e$$

17) (a)

$$i^2 R t = 1000 \Rightarrow 4 \times R \times 6 \times 60 = 1000$$

$$\therefore R = \frac{25}{36}$$

$$\therefore E - iR = 0 \Rightarrow E = iR = 2 \times \frac{25}{36} = \frac{50}{36}$$

$$\therefore E = 1.38V$$

18) (b)

$$X - i(r + R) = 0$$

$$Y = iR \Rightarrow i = \frac{Y}{R}$$

$$\therefore X - iR - iR = 0 \Rightarrow X - iR - Y = 0 \Rightarrow iR = X - Y$$

$$\therefore Y \frac{Y}{R} = (X - Y) \Rightarrow Y = \frac{R(X - Y)}{Y}$$

19) (c)

49

$$2 - (998 + 2)i = 0 \Rightarrow i = \frac{2}{1000} = 2 \times 10^{-3}$$

a. ~~Wavy line~~ 2×10^{-3}

$$V = E - iR$$

$$\therefore \text{Error} = iR = 2 \times 10^{-3} \times 2$$

$$\therefore \text{Error} = 4 \times 10^{-3} \text{ V}$$

21) (c)

$$\text{EMF}_{\text{total}} = e(N-n) + e(-n)$$

$$= e(N-2n)$$

22) (b)

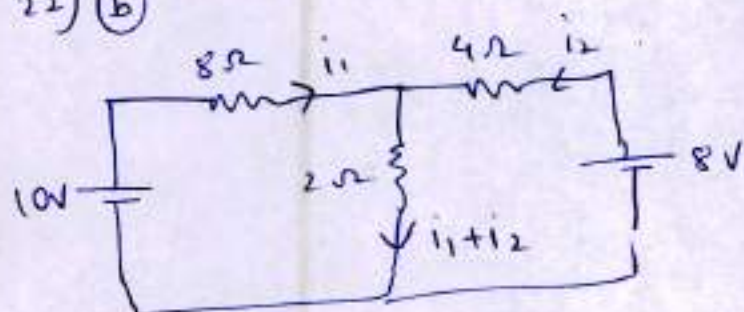

$$10 - 8i_1 - 2(i_1 + i_2) = 0$$

$$8 - 4i_2 - 2(i_1 + i_2) = 0$$

$$\therefore 10 - 8i_1 = 8 - 4i_2$$

$$\therefore 2 = 8i_1 - 4i_2$$

$$\therefore 4i_1 - 2i_2 = 1$$

$$\therefore i_1 = \frac{1 + 2i_2}{4}$$

$$10 - 8\left(\frac{1 + 2i_2}{4}\right) - 2\left(\frac{1 + 2i_2}{4} + i_2\right) = 0$$

$$\therefore 10 - 2 - 4i_2 - \frac{(1 + 6i_2)}{2} = 0$$

$$\therefore 16 - 8i_2 = 1 + 6i_2$$

$$\therefore i_2 = \frac{15}{14} \Rightarrow i_1 = \frac{22}{28}$$

$$\therefore i_1 + i_2 = \frac{52}{28} = \frac{13}{7}$$

24) (a)

$$R_{eq} = 60 \parallel 20 \parallel 10 = 6 \Omega$$

$$\therefore V = 1 \times 6 = 6V$$

$$\therefore 60 \times I = 6 \Rightarrow \boxed{I = 0.1V}$$

25) (b)

$$V = E - ir$$

27) (a)

$$E \text{ in each row} = 0.15 \times 5000 = 750V$$

$$r \text{ in each row} = 0.25 \times 5000 = 1250 \Omega$$

Now for all rows, $E_{eq} = 750V$

$$r_{eq} = \frac{1250}{100} = 12.5 \Omega$$

$$\therefore 750 - (12.5 + 500) i = 0$$

$$\therefore \boxed{i \approx 1.5A}$$

29) (c)

$$q = \int I dt = \int_0^5 (1.2t + 3) dt = 0.6 \times 25 + 15$$

$$\therefore \boxed{q = 30C}$$

30) (b)

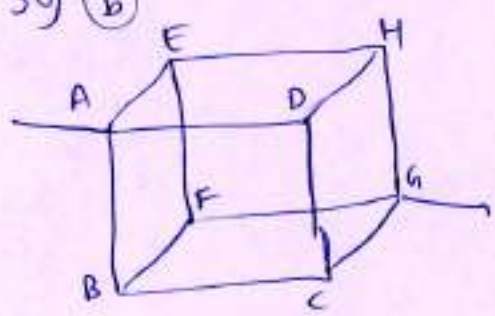

Due to symmetry, points E, D, B will be equipotential and points H, F, C are equipotential.

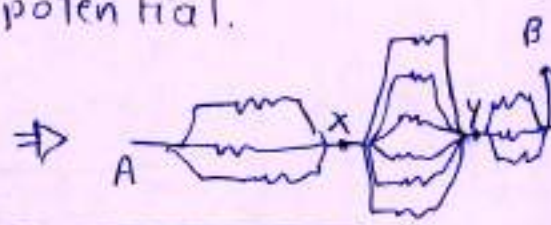
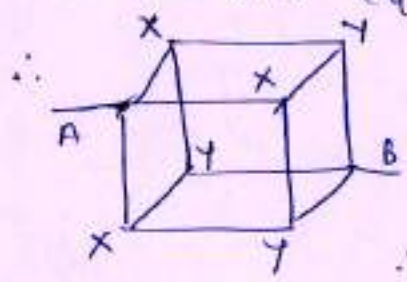

$$\therefore \boxed{R_{eq} = \frac{R}{3} + \frac{R}{6} + \frac{R}{3} = \frac{5R}{6}}$$

There are 6 resistances between X and Y

Different Measuring Instruments

1) (c)

$$0.002 \times G = 0.998 \times Y$$

$$\therefore Y = \frac{1}{499} G$$

2) (d)

$$\frac{S}{l_1} = \frac{R}{100 - l_1} \quad \text{--- (1)}$$

when shunted with equal resistance, $R_{eq} = R/2$

$$\therefore \frac{S}{1.6l_1} = \frac{R}{2(100 - 1.6l_1)} \quad \text{--- (2)}$$

Dividing (1) by (2),

$$1.6 = \frac{2(100 - 1.6l_1)}{(100 - l_1)} \Rightarrow 160 - 1.6l_1 = 200 - 3.2l_1$$

$$\therefore l_1 = 25$$

$$\therefore 1.6l_1 = 40$$

$$\therefore \frac{1}{5} = \frac{R}{100 - 25} \Rightarrow 100 - 25 = 5R$$

$$\boxed{R = 15 \Omega}$$

3) (a)

$$E = 32$$

$$E - (9.5 + r)i = 0 \Rightarrow i = \frac{E}{9.5 + r}$$

(z = potential drop per unit length)

$$E - ir = 2.85z$$

$$\therefore E - \frac{EY}{(9.5 + r)} = 2.85z$$

$$\therefore 32 \left(\frac{9.5 + r - Y}{9.5 + r} \right) = 2.85z \Rightarrow 3 \times 9.5 = 2.85(9.5 + r)$$

$$\therefore \boxed{Y = 0.5 \Omega}$$

4) (b)

$$99 \times 0.1 \hat{i} = r \times 0.9 \hat{i}$$

$$\boxed{r = 11 \Omega}$$

6) (b)

$$0.03 \times \frac{4rR}{4r+R} = 0.06 \times \frac{rR}{r+R}$$

$$\therefore \frac{2rR}{4r+R} = \frac{1}{r+R} \Rightarrow R = 2r$$

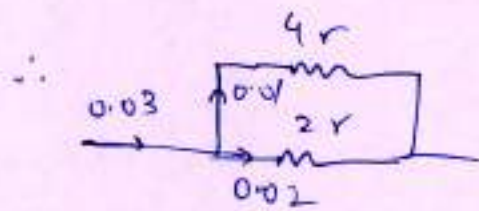

$$\therefore \text{Current through galvanometer} = 0.02 \text{ A}$$

7) (d)

$$\frac{E_1}{E_1 - E_2} = \frac{3}{1} \Rightarrow \frac{E_1 - E_2}{E_1} = \frac{1}{3} \Rightarrow \frac{E_1 - E_2 - E_1}{E_1} = -\frac{2}{3}$$

$$\therefore \frac{E_2}{E_1} = \frac{2}{3} \Rightarrow \boxed{\frac{E_1}{E_2} = \frac{3}{2}}$$

8) (c)

$$15 \times 2 \times 10^{-3} = (5 - 2 \times 10^{-3}) \times r$$

$$\therefore r = \frac{15 \times 2 \times 10^{-3}}{5 - 2 \times 10^{-3}} \approx 0.06 \Omega$$

9) (a)

Deflection \propto current

$$\therefore \frac{30}{20} = \frac{E/3000}{E/R} \Rightarrow \frac{3}{2} = \frac{R}{3000}$$

$$\therefore R = 4500$$

$$\therefore R_s + r = 4500 \Rightarrow \boxed{R_s = 4450}$$

10) (d)

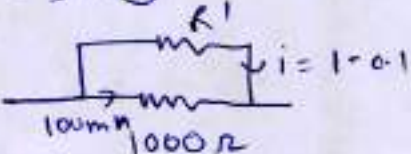

$$1000 \times 0.1 = R' \times 0.9$$

$$\therefore R' = \frac{1000}{9}$$

$$\therefore R' = 111.11$$

12) (c)

$$\frac{r_1}{r_2} = \frac{20}{80} = \frac{1}{4} \Rightarrow r_2 = 4r_1$$

$$\frac{r_1 + 15}{4r_1} = \frac{40}{60} = \frac{2}{3} \Rightarrow 3r_1 + 45 = 8r_1$$

$$\therefore 5r_1 = 45$$

$$\boxed{r_1 = 9}$$

13) (d)

$$56 \text{ V} - 2 \text{ V} - i(2 \times 4) = 0$$

$$\therefore 3.6 \text{ V} = 8i$$

$$i = \frac{3.6}{8}$$

$$\therefore \boxed{i = 0.45 \text{ A}}$$

14) (d)

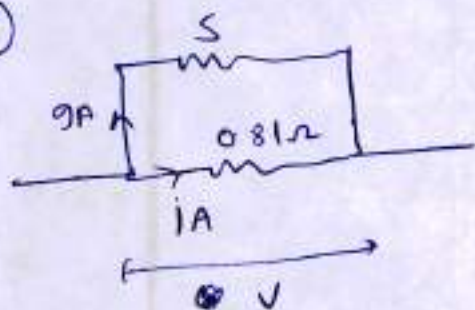

$$\therefore 0.81 \times i = 9 \times S$$

$$\therefore S = \frac{0.81}{9}$$

$$\therefore \boxed{S = 0.09 \Omega}$$

15) (d)

$$E = 30z$$

(z = voltage drop per unit length)

$$\therefore \boxed{E = 30 \times \frac{E}{100}}$$

No current flows if shunt is not applied

16] (a)

$$36 \times i_1 = 4(i - i_1) \Rightarrow 9i_1 = i - i_1$$

$$\therefore i_1 = \frac{i}{10}$$

17] (b)

$$100 \text{ mV} = i \times 100$$

$$\therefore i = 1 \text{ mA}$$

$$\therefore 100 \times 10^{-3} = S(S - 0.001)$$

$$\therefore S = \frac{0.1}{S}$$

$$\therefore S = 0.02 \Omega$$

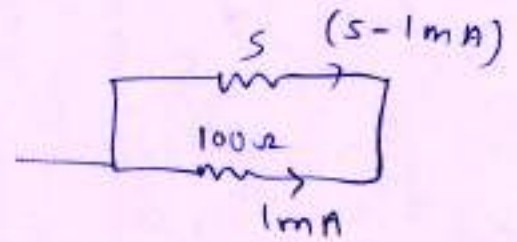

19] (c)

$$\frac{E}{3} = \frac{60}{45} \Rightarrow E = 4 \text{ V}$$

20] (c)

$$V_G = 10 \times 10^{-3} = 0.01$$

$$\therefore 2.5 = (10 + R) 10^{-3}$$

$$\therefore R = 2490 \Omega$$

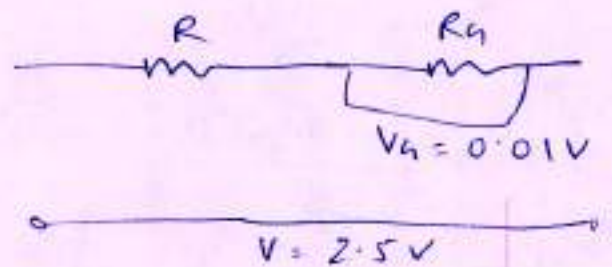

21] (b)



$$i_1 + i_2 = n i_1 \Rightarrow i_2 = (n-1) i_1$$

$$S i_2 = R i_1$$

$$\therefore S(n-1) i_1 = R i_1 \Rightarrow R = S(n-1)$$

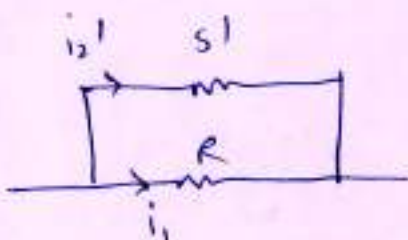

$$i_1 + i_2' = n' i_1$$

$$R i_1 = S' i_2'$$

$$i_2' = (n'-1) i_1$$

$$\therefore R i_1 = S' (n'-1) i_1 \Rightarrow S(n-1) = (n'-1) S'$$

$$n' = \frac{S(n-1) + S'}{S'}$$

22) (a)

$$\frac{E_1 + E_2}{E_1 - E_2} = \frac{6}{2} \Rightarrow \frac{E_1}{E_2} = \frac{8}{4} = \frac{2}{1}$$

55

23) (a)

$$10 \times i = 50 \times 2 \times 10^{-3}$$

24) (c)

$$\frac{3}{Q} = \frac{55}{45} = \frac{11}{9} \Rightarrow Q = \frac{27}{11}$$

~~Q~~
$$\frac{3+x}{27/11} = \frac{75}{25} = \frac{3}{1}$$

$$11(x+3) = 81$$

$$\therefore x = \frac{81}{11} - 3$$

$$\therefore \boxed{x = \frac{48}{11}}$$

25) (a)

$$15 \times 4 \times 10^{-3} = Y(6 - 4 \times 10^{-3})$$

$$\therefore Y = \frac{15 \times 4 \times 10^{-3}}{6}$$

$$\therefore \boxed{Y = 10 \text{ m}\Omega}$$

This should be connected in parallel.

27) (c)

$$i = \frac{2}{990 + 10} = 2 \times 10^{-3}$$

$$\therefore V_{\text{wire}} = iR = 2 \times 10^{-3} \times 10 = 2 \times 10^{-2}$$

$$\therefore \text{Potential gradient} = \frac{V_{\text{wire}}}{L} = \frac{2 \times 10^{-2}}{2} = 0.01 \text{ V/m}$$

28) (a)

56

$$\frac{E}{E - iY} = \frac{110}{100} = \frac{11}{10}$$

$$E - i(Y+10) = 0 \Rightarrow i = \frac{E}{Y+10}$$

$$\therefore \frac{E}{E - \frac{EY}{Y+10}} = \frac{11}{10} \Rightarrow \frac{10(Y+10)}{10} = 11$$

$$\therefore \boxed{Y = 1 \Omega}$$

31) (b)

$$V = iR \Rightarrow 2 = i \times 300 \Rightarrow i = \frac{1}{150} \approx 6 \text{ mA}$$

\(\therefore\) option b. as all others are more than 6 mA.

33) (d)

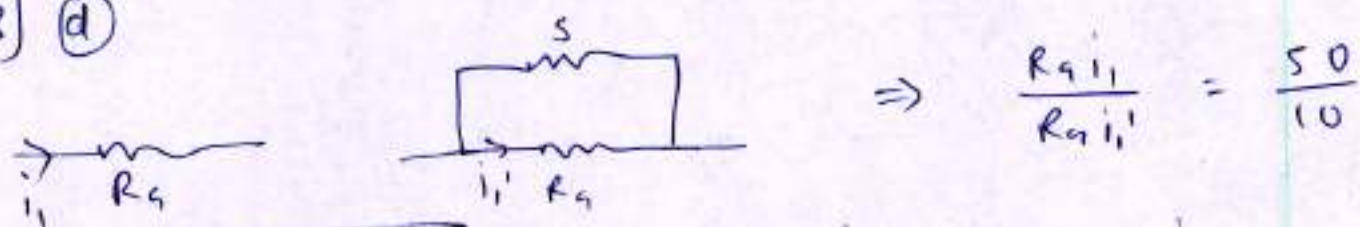

$$\Rightarrow \frac{R_g i_1}{R_g i_1'} = \frac{50}{10}$$

$$\therefore \boxed{i_1' = \frac{i_1}{5}}$$

$$\therefore R_g \times \frac{i_1}{5} = 5 \times \frac{4i_1}{5}$$

$$\therefore R_g = 4 \times 5$$

$$\therefore \boxed{R_g = 4 \times 12 = 48 \Omega}$$

35) (d)

For 25 division $i = 25 \times 4 \times 10^{-4} \text{ A}$

$$\therefore i = 10^{-2} \text{ A}$$

$$\text{Now } (R+50)i = 25 \text{ V}$$

$$\therefore R+50 = 25 \times 10^2$$

$$\therefore R = 2500 - 50$$

$$\therefore \boxed{R = 2450}$$

36) (a)

57

$$n i^0 = V \quad \text{--- (1)}$$

$$(n+R) i^0 = nV \quad \text{--- (2)}$$

$$\therefore \frac{n+R}{n} = n \quad (\text{Dividing (2) by (1)})$$

$$\therefore \frac{n}{R} = \frac{1}{n-1} \Rightarrow \boxed{R = n(n-1)}$$

37) (d)

$$R_0 I = (R_0 + R) \frac{I}{n}$$

$$\therefore R_0 n = R_0 + R$$

$$\therefore R = R_0(n-1)$$

39) (c) repeated que.

40) (a)

$$i^0 = 30 \times 16 \times 10^{-6}$$

$$\therefore i^0 R = V \Rightarrow 3 = 48 \times 10^{-4} \times R$$

$$\therefore R = \frac{3}{4.8} \times 10^{-4} \approx 6 \text{ k}\Omega$$

41) (c)

$$6 \times 2 = (6-2)R = 4R$$

$$\therefore \boxed{R = 3 \Omega}$$

42) (a)

$$(R+V) 0.1 = 12$$

$$\therefore R+V = 120 \Rightarrow R+2 = 120$$

$$\therefore \boxed{R = 118 \Omega}$$

43) (c)

$$\frac{E}{E - iV} = \frac{75}{65}$$

$$E - i(R+V) = 0 \Rightarrow i^0 = \frac{E}{(R+V)}$$

$$\therefore \frac{1}{1 - \frac{V}{(R+V)}} = \frac{75}{65} \Rightarrow \boxed{V = 1.54 \Omega}$$

44] (a)

$$V = 0.2 \times 10 = 2 \text{ V}$$

$$\therefore R \times (1.8 \times 0.2) = 2$$

$$\therefore R = \frac{2}{1.6} = \frac{5}{4} = 1.25 \Omega$$

45] (d)

$$V = 40 \times 10 \times 10^{-3} = 0.4 \text{ V}$$

$$\therefore (50 - 0.4) = 10 \times 10^{-3} R$$

$$\therefore \frac{49.6}{10^{-2}} = R \Rightarrow R = 4960 \Omega$$

46] (a)

$$R_1 + 10 = R_2$$

$$\frac{R_1}{R_2} = \frac{40}{60} = \frac{2}{3} \Rightarrow R_2 = \frac{3}{2} R_1$$

$$\therefore R_1 + 10 = \frac{3}{2} R_1 \Rightarrow \frac{1}{2} R_1 = 10 \Rightarrow R_1 = 20 \Omega$$

47] (c)

~~12 resistors~~

For maximum current, R should be minimum

\therefore All 12 Ω resistors should be connected in parallel

$$\therefore R_{eq} = \frac{12}{3} = 4 \Omega$$

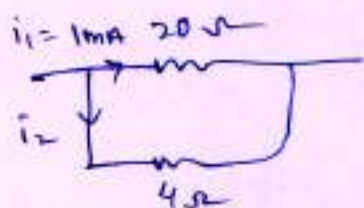

$$\therefore i_2 = \frac{20}{24} \times i_1$$

$$\therefore i_2 = \frac{20}{40} \times 1$$

$$\therefore i_2 = 5 \text{ mA}$$

$$\therefore i_{net} = i_1 + i_2 = 1 + 5 = 6 \text{ mA}$$

Heating Effects of Current

59

1) a)

$$P = \frac{V^2}{R} ; R \propto \frac{1}{P}$$

$$P_1 = 40 ; P_2 = 100 \\ \therefore R_1 > R_2$$

In series, the current will be the same.

$$\therefore \frac{P_1}{P_2} = \frac{i^2 R_1}{i^2 R_2} = \frac{R_1}{R_2} \quad \therefore P_1 > P_2$$

\therefore 40W bulb will glow brighter

In parallel connection

$$\frac{P_{P1}}{P_{P2}} = \frac{V^2/R_1}{V^2/R_2} = \frac{R_2}{R_1}$$

$$\therefore P_{P2} > P_{P1}$$

\therefore 100W bulb will glow brighter in parallel connection

2) b)

Repeated question (0.12 of Level 12)

3) d)

$$P = \frac{V^2}{R}$$

$$P' = \frac{(0.9V)^2}{R} = 0.81 \frac{V^2}{R} = 81W$$

4)

a)

$$P = \frac{V^2}{R} = i^2 R \Rightarrow R = \frac{V^2}{P}$$

$$\therefore P = i^2 R = i^2 \frac{V^2}{P} \Rightarrow i^2 = \frac{V^2}{P^2} \Rightarrow i = \frac{V}{P}$$

$$R_1 = \frac{(220)^2}{60} ; R_2 = \frac{(220)^2}{100}$$

$$\therefore R_{eq} = R_1 + R_2 = (220)^2 \left[\frac{1}{60} + \frac{1}{100} \right] = 1290.6 \Omega$$

$$i = \frac{220}{R_{eq}}$$

$$\therefore P = i^2 R_{eq} = \frac{(220)^2}{R_{eq}^2} \times R_{eq} = \frac{(220)^2}{1290.6} = 37.5W$$

5) (a)

$$P = \frac{V^2}{R} \Rightarrow \text{At } V' = \frac{1}{2}V \Rightarrow P' = \frac{(V/2)^2}{R} = \frac{V^2}{4R}$$

$$\therefore P' = \frac{P}{4} = \frac{100}{4} = 25 \text{ W}$$

60

6) (c)

$$\frac{(200)^2}{R_1} = \frac{(300)^2}{R_2} \Rightarrow \frac{R_1}{R_2} = \frac{4}{9}$$

In series, current will be same through both bulbs

$$\therefore \frac{P_1}{P_2} = \frac{i^2 R_1}{i^2 R_2} = \frac{R_1}{R_2} = \frac{4}{9}$$

7) (b)

$$220 - 10R_{eq} = 0 \Rightarrow R_{eq} = 22$$

All lamps are in parallel

$$\therefore R_{eq} = \frac{R}{n} \Rightarrow 22 = \frac{V^2}{\frac{P}{n}} \Rightarrow 22n = \frac{220 \times 220}{100}$$

$$\therefore 22n = 22 \times 22$$

$$\therefore \boxed{n = 22}$$

8) (b)

$R = \frac{\rho l}{A} \Rightarrow$ length is reduced by 10%, so Resistance will also reduce by 10%.

$$\therefore R' = 0.9R$$

$$P' = \frac{V^2}{0.9R} = \frac{P}{0.9}$$

$$P \times 16 = P' \times t$$

$$\therefore P \times 16 = \frac{P}{0.9} \times t \Rightarrow t = 0.9 \times 16 \Rightarrow \boxed{t = 14.4 \text{ min}}$$

9) (c)

When the key is opened, the net resistance of circuit increases, so the total current in circuit decreases, and current through B_2 will increase.

\therefore Brightness of B_1 decreases and B_2 increases.

10) (b)

61

$$\text{Power} \times t = m c \Delta T$$

$$\therefore \text{Power} \times 60 = 10^3 \times 4.184 \times 15$$

(density of water
= 1 g ml cm^{-3})

$$\therefore \boxed{\text{Power} = 1050 \text{ W}}$$

11) (b)

12) (b)

$$R_{eq} = 2R$$

$$\therefore i_1 \times R = i_2 (2R) \Rightarrow i_2 = i_1/2$$

$$\therefore P' = \left(\frac{i_1}{2}\right)^2 R = \frac{i_1^2 R}{4}$$

$$\therefore P' = \frac{P}{4}$$

$$\therefore P_{eq} = 2P' = \frac{P}{4} + \frac{P}{4} = \frac{P}{2}$$

$$\therefore P \times 10 = P' \times t$$

$$\therefore P \times 10 = \frac{P}{2} \times t$$

$$\therefore \boxed{t = 20 \text{ min}}$$

13) (c)

$$P = Vi = 50 \times 12 = 600$$

$$0.7 \times 600 = i^2 R$$

$$R = \frac{0.7 \times 600}{144}$$

$$\therefore \boxed{R = 2.91 \Omega}$$

14) (b)

$$\frac{V^2}{R_1} t_1 = \frac{V^2}{R_2} t_2 \Rightarrow \frac{R_1}{t_1} = \frac{R_2}{t_2} \Rightarrow \frac{R_2}{R_1} = \frac{t_2}{t_1} \quad \text{--- (1)}$$

$$\therefore \frac{R_2 + R_1}{R_1} = \frac{t_2 + t_1}{t_1} \quad \text{--- (1)}$$

Now, when connected in series, $R_{eq} = R_1 + R_2$
 Same heat is required.

$$\therefore \frac{V^2}{R_1} t_1 = \frac{V^2}{(R_1 + R_2)} t'$$

$$\therefore t' = \left(\frac{R_1 + R_2}{R_1} \right) t_1$$

$$\therefore t' = \frac{(t_2 + t_1)}{t_1} t_1 \quad \text{[from (1)]}$$

$$\therefore \boxed{t' = t_1 + t_2}$$

15) (c)

$$R = \frac{V^2}{P} \Rightarrow R \propto \frac{1}{P}$$

$$R = \frac{\rho l}{A} \Rightarrow R \propto \frac{l}{A}$$

$$\therefore A \propto P$$

~~60~~ 60 W bulb has more area i.e. it is thicker.

16) (b)

$$160 = \frac{3600}{R} = i^2 R \Rightarrow R = \frac{3600}{160}$$

$$\therefore 160 = i^2 \frac{3600}{160} \Rightarrow i^2 = \frac{160 \times 160}{3600}$$

$$\therefore i = \frac{4 \times 4}{6} = \frac{8}{3} \text{ A}$$

$$\therefore n = \frac{60 \times 8}{1.6 \times 10^{-19} \times 3} = 10^{21}$$

17) (b)

$$P = i^2 R = \frac{V^2}{R} \quad ; \quad R_1 = \frac{(220)^2}{100} \quad R_2 = \frac{(220)^2}{60} \quad 63$$

$$\therefore R_{eq} = R_1 + R_2$$

\therefore Power consumed by 100W bulb = $i^2 R_1$

$$\therefore P = \left(\frac{V}{R_1 + R_2} \right)^2 R_1 = \left(\frac{V}{\frac{V^2}{100} + \frac{V^2}{60}} \right)^2 \times \frac{V^2}{100}$$

$$\therefore P = \left(\frac{600}{160} \right)^2 \times \frac{1}{100}$$

$$\therefore P = \frac{150 \times 150}{16} \times \frac{1}{100}$$

$$\therefore \boxed{P = 14.06 \text{ W}}$$

18) (a)

$$R = \frac{1}{Y_{eq}}$$

$$Y_{eq} = \frac{Y}{2}$$

$$\therefore \boxed{R = \frac{Y}{2}}$$

19) (c)

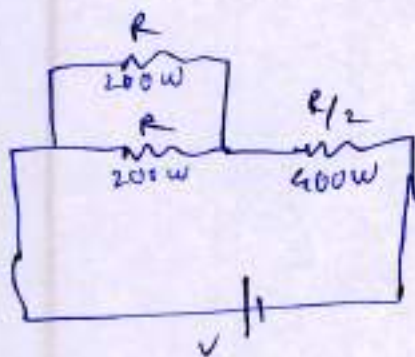

$$P = \frac{V^2}{R} \Rightarrow R = \frac{V^2}{P}$$

Let the resistance of 200W bulb be R

$$\therefore \text{Resistance of } 400\text{W bulb} = \frac{R}{2}$$

$$\therefore R_{eq} = \frac{R}{2} + \frac{R}{2} = R$$

($2R$ in parallel)

$$\therefore P_{eq} = \frac{V^2}{R_{eq}} = \frac{V^2}{R} = 200\text{W}$$

21) (d)

$$\frac{60}{20} = \frac{75}{(20+r)} \Rightarrow 60 + 3r = 75$$

$$\therefore \boxed{r = 5 \Omega}$$

22) (a)

$$P_1 = \frac{V^2}{R_1} ; P_2 = \frac{V^2}{R_2} \Rightarrow R_1 = \frac{V^2}{P_1} ; R_2 = \frac{V^2}{P_2}$$

Now in series, $P_{eq} = i^2 R_{eq}$

$$R_{eq} = R_1 + R_2$$

$$i = \frac{V}{(R_1 + R_2)}$$

$$\therefore P_{eq} = \frac{V^2}{(R_1 + R_2)^2} \times (R_1 + R_2) = \frac{V^2}{(R_1 + R_2)}$$

$$R_1 + R_2 = \frac{V^2}{P_1} + \frac{V^2}{P_2} = V^2 \left(\frac{P_1 + P_2}{P_1 P_2} \right)$$

$$\therefore P_{eq} = \frac{V^2}{V^2 \left(\frac{P_1 + P_2}{P_1 P_2} \right)} = \frac{P_1 P_2}{P_1 + P_2}$$

23) (a)

$$P = \frac{V^2}{R} ; P' = \frac{V^2}{2R}$$

$$\therefore P' = \frac{P}{2}$$

24) (c)

25) (d)

~~Power~~ Power = $V I$

Energy = $V I t$

If x is the efficiency, then

$$\frac{x}{100} \times (15 \times 10 \times 8) = (14 \times 5 \times 15)$$

$$\therefore x = \frac{14}{16} \times 100 \Rightarrow \boxed{x = 87.5\%}$$

26) (d)

$$R_{eq} = 3R$$

$$\therefore P_{eq} = \frac{V^2}{R_{eq}} = \frac{V^2}{3R} = \frac{P}{3}$$

$$\therefore P_{eq} = \frac{60}{3} = 20 \text{ W}$$

65

27) (d)

$$P = i^2 R \Rightarrow 1 = (5)^2 R$$

$$\therefore R = \frac{1}{25} = 0.04 \Omega$$

28) (d)

$$P_{eq} = \frac{V^2}{R_{eq}} = V^2 \left(\frac{1}{R_1} + \frac{1}{R_2} \right) = \frac{V^2}{R_1} + \frac{V^2}{R_2} = 2 \frac{V^2}{R} = 2P$$

($R_1 = R_2$)

$$\therefore P_{eq} = 2 \times 1000 = 2000 \text{ W}$$

29) (b)

$$P = \frac{V_{rms}^2}{R} ; V_{rms} = \frac{V_m}{\sqrt{2}} = \frac{220}{\sqrt{2}}$$

$$\therefore \text{Heat produced} = \text{Power} \times \text{time}$$

$$= \frac{\left(\frac{220}{\sqrt{2}} \right)^2}{110} \times 7 \times 60 \text{ Joule}$$

$$\therefore \text{Heat} = \frac{220 \times 220 \times 7 \times 60}{2 \times 110 \times 4.18} \text{ cal}$$

$$\therefore \text{Heat} = 22 \times 10^3 \text{ cal}$$

30) (c)

R_2 should be equal to R_3

$$\therefore P_{R_1} = P_{R_2} = P_{R_3}$$

$$\therefore i^2 R_1 = \left(\frac{i}{2} \right)^2 R_2$$

$$\therefore R_1 = \frac{R_2}{4}$$

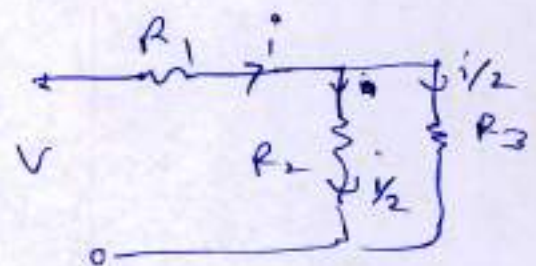

31) (c)

66

$$R_{eq} = 3R$$

$$\therefore P = \frac{V^2}{3R} = \frac{1}{3} \times \frac{V^2}{R} = \frac{1}{3} P_0$$

$$\therefore P_0 = 3P$$

i.e. Power if ~~four~~ single bulb is connected will be $3P$

\therefore When 3 bulbs connected in parallel,

$$P_p = \frac{V^2}{R_{eq}} = \frac{V^2}{R/3} = 3P_0$$

$$\therefore P_p = 3P_0 \\ = 3 \times 3P$$

$$\therefore \boxed{P_p = 9P}$$

Thermoelectricity

67

1) (a)

$$\frac{dE}{dt} = 0 \Rightarrow a + 2bt = 0$$

$$\therefore t = \boxed{-\frac{a}{2b}}$$

4) (a)

$$25 \times 10^{-6} \times dT = 4 \times 10^{-1} \times 10^{-3}$$

$$\therefore 25 \times 10^{-2} dT = 4$$

$$\therefore dT = \frac{400}{25} = 16^\circ\text{C}$$

Chemical Effect of Current

68

1) (b)

Mass deposited is proportional to charge passed.
Let the mass deposited x .

$$\therefore \frac{12 \times 30}{2} = \frac{6 \times 45}{x}$$

$$\therefore x = 1.5 \text{ g}$$

2) (c)

$$W = Z A t$$

$$P = V i \Rightarrow i = \frac{P}{V} = \frac{100 \times 10^3}{125} = \frac{4}{5} \times 10^3$$

$$\therefore W = 0.367 \times 10^{-6} \times \frac{4}{5} \times 10^3 \times 60$$

$$\therefore W = 17.61 \times 10^{-3} \text{ kg}$$

3) (b)

Let the thickness be t .

$$\therefore \text{Mass deposited} = 9 \times 10^3 \times 0.05 \times t \text{ kg}$$

$$\therefore 9 \times 10^3 \times 0.05 t = 2 A t$$

$$\therefore t = \frac{3.04 \times 10^{-7} \times 1 \times 60 \times 60}{9 \times 10^3 \times 0.05}$$

$$\therefore t = 2.4 \text{ pm}$$

7) (d)

$$W = Z A t = 30 \times 10^{-5} \times 1.5 \times 10 \times 60 = 0.27 \text{ g}$$

9) (c)

$$\frac{0.13}{32.5} = \frac{x}{31.5} \Rightarrow x = \frac{0.13 \times 31.5}{32.5} \Rightarrow x = 0.126 \text{ g}$$

10) (a)

$$i = \frac{P}{V} = \frac{4}{5}$$

$$W = 0.367 \times 10^{-6} \times \frac{4}{5} \times 60$$

$$\therefore W = 17.6 \text{ mg}$$